



Automation systems

Intelligent automation in the control cabinet and field



RSPSupply - 1-888-532-2706 - <https://www.RSPSupply.com>
See the product details here

Open to the future

The world of automation is changing. The digitalization, networking, and globalization of business and technical systems are generating new market requirements. Manufacturers of future-oriented automation systems must be ready to provide their customers with the ability to meet the standards of modern IoT applications. Phoenix Contact therefore provides future-oriented PLCs, I/O systems, and PLC software. From components through to the complete system – for the control cabinet and field installation. Professional automation for your systems: from distributed water supply through to highly complex painting lines in the automotive industry.

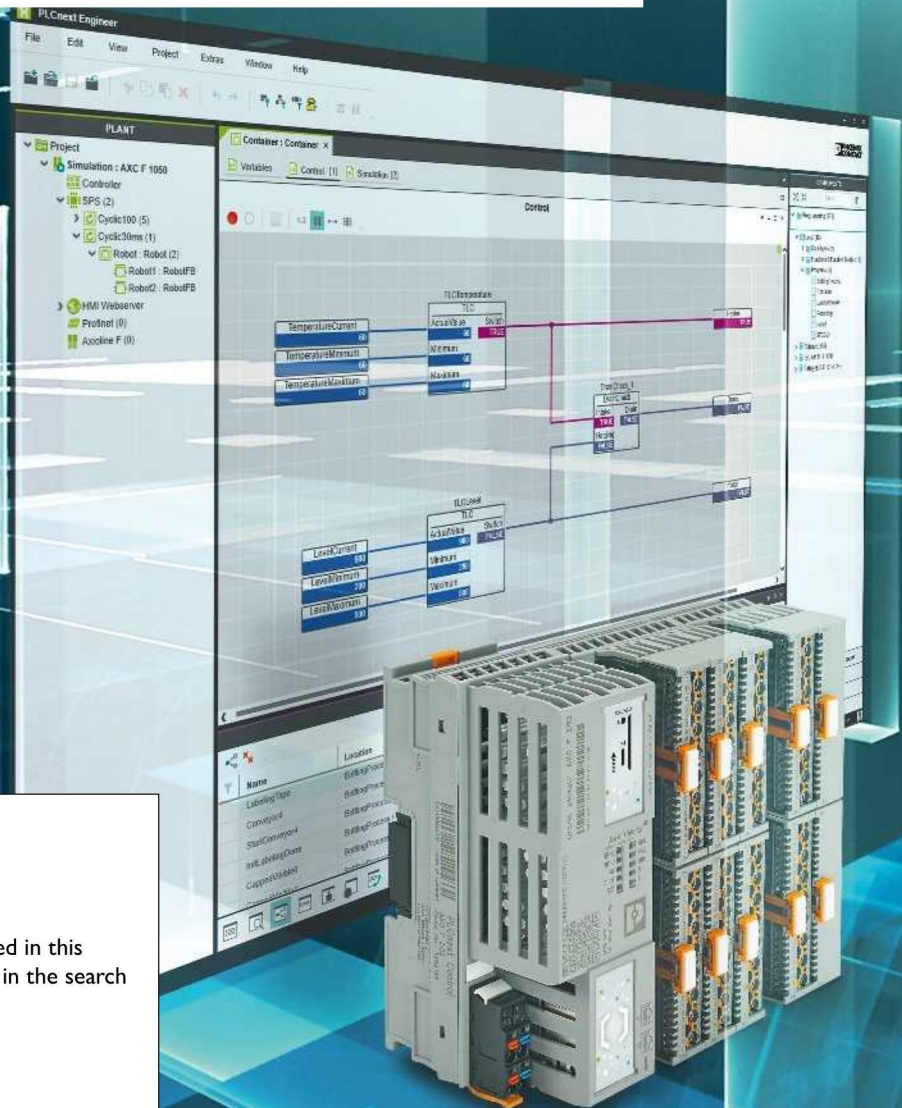

Find out more with the web code

For detailed information, use the web codes provided in this brochure. Simply enter # and the four-digit number in the search field on our website.

i Web code: #1234 (example)

Or use the direct link:
[phoenixcontact.net/webcode/#1234](https://www.phoenixcontact.net/webcode/#1234)



Contents

High-performance controllers	4
Safe PLCnext Control	6
Redundant PLCs	8
Modular automation system	10
PLCnext Control devices	12
PLCs for IEC 61131-3	14
Bus couplers	16
I/Os	18
I/O system for field installation	26
Distributed I/Os	28
IO-Link	30
Engineering software	32
PLCnext Engineer	34
Other automation software	38
Product overview	40

PLCnext Technology

Designed by PHOENIX CONTACT

PLCnext Technology is the unique, open ecosystem for modern automation. The combination of open control platform, modular engineering software, a growing online community, and software store enables easy adaptation to changing demands in the world of automation.

Find out more at: plcnext-community.net

COMPLETE line

COMPLETE line is a system comprising coordinated hardware and software products, consulting services, and system solutions that help you optimize your processes in control cabinet manufacturing.

High-performance controllers

The high-performance controllers (Remote Field Controllers) enable you to implement automation applications that place high demands on safety or availability, for example. For applications with PLCnext Technology requiring the highest safety level, play it safe with our safety controller up to SIL 3. Redundant control systems help you reduce downtimes, work cost-effectively, and also avoid potential dangers, e.g., in tunnels or at airports.

PLCnext Technology 
Designed by PHOENIX CONTACT

Safe PLCnext Control

It is suitable for use in applications with the highest safety requirements in accordance with SIL 3 or PLe, respectively.

Your advantages

- ✓ Integration of PLCnext Technology
- ✓ Standard and safety programming with PLCnext Engineer
- ✓ Implementation of the highest safety requirements in accordance with SIL 3 or PLe, respectively
- ✓ Connection to Proficloud and use of apps from the PLCnext Store



Tutorials for technical support on YouTube

Watch tutorials on the Phoenix Contact Technical Support YouTube channel and find out more about all aspects of control technology, e.g., basic and advanced training courses on PLCnext Technology or connection of Phoenix Contact I/O systems.

phoe.co/YouTube-TechnicalSupport

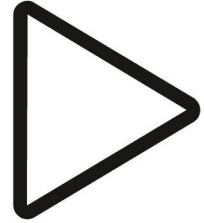

Redundant PLCs for IEC 61131-3

Maximum system availability with redundancy

Your advantages

- ✓ Maximum system availability with redundancy
- ✓ Easy startup and automatic configuration of all redundancy functions with AutoSync Technology
- ✓ Uninterrupted process in the event of failure or when a controller is replaced
- ✓ PROFINET standards ensure optimum device integration; redundancy for your future-proof Ethernet network

High-performance controllers

Safe PLCnext Control

The first PLCnext Control that combines standard and safety-relevant calculations in one device. As a part of the open PLCnext Technology ecosystem, parallel programming based on established software tools is possible. This enables you, for example, to freely combine functions in accordance with IEC 61131-3 with routines from C/C++, C# or MATLAB® Simulink®, and to merge these to create a complete system. You can connect to Proficloud directly, and integrate individual cloud services.

 Web code: #2215

PLCnext Technology 
Designed by PHOENIX CONTACT



Safe PLCnext Control



High-performance safety PLC

RFC4072 S

Order No. 1051328

- PROFINET controller and device
- Support for PROFIsafe Profile V2.6.1
- Safety CPU: 1x ARM® Cortex®-A9, 800 MHz, 1x ARM® Cortex®-A8, 600 MHz
- Standard CPU: Intel® Core™ 5-6300U (dual core, 2.4 GHz)
- M2M system networking with OPC UA
- Standard and safety programming with PLCnext Engineer

Making wind turbines safe

One specific field of application for a safety controller is, for example, the adjustment of the rotor blades of a wind turbine generator (pitch control). As part of the pitch control system, the current rotor blade position can be detected and, for example, transmitted to an RFC 4072S. The set point of the rotor blade position is calculated based, among other things, on the failsafe detection of the prevailing wind speed via an anemometer, which is then

processed in the safety-oriented program of the RFC 4072S. If the wind speed exceeds a critical value in a short period of time due to a gust of wind, the wind turbine generator controller starts to turn the rotor blade out of the wind.



PLCnext Store – install unexpected possibilities

Store user

Accelerate your application development process and use solution apps. In the PLCnext Store, you can download ready-to-use solutions to your PLCnext Control device and create your application quickly – without any deep understanding of programming. This means that, thanks to the PLCnext Store, a PLCnext Control device can, for example, be transformed into a solar park PLC easily and without programming. Phoenix Contact already provides numerous software libraries for PLCnext Engineer which are now available for download in the PLCnext Store. These libraries include, for example, data logger functions and remote control protocols. You therefore receive optimum support in the efficient programming of your PLCnext Control device.

Contributor

Do you lack access to hardware distribution or the platform for your software solution? Become a contributor to the PLCnext Store and benefit from the unique ecosystem.

Make your software solutions available to a huge range of potential customers. This will not only enable you to increase your income, but also boost your profile and visibility in a field of industry that is relevant to you.
plcnextstore.com

Join the PLCnext Community

The PLCnext Community provides information, support, and useful resources for PLCnext Technology. Ask a question in the forum, find answers to frequently asked questions, watch tutorials, and keep up to date via GitHub and Instagram: plcnext-community.net

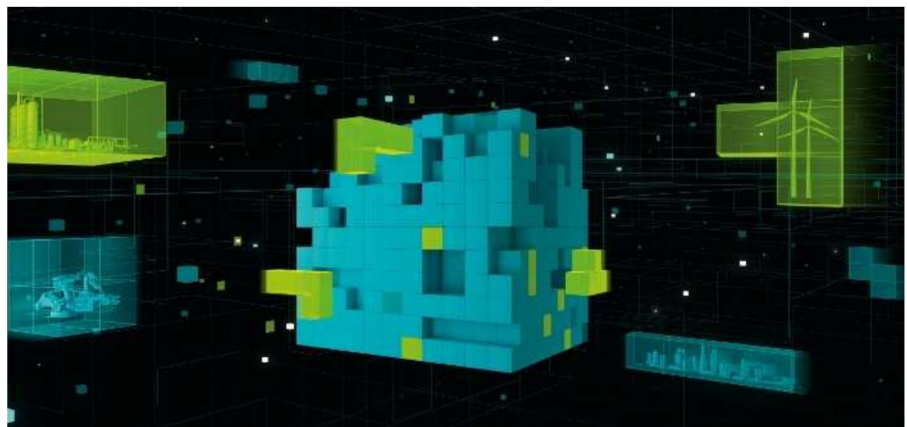

High-performance controllers

Redundant PLCs for IEC 61131-3

When it comes to high-availability, distributed, and modular automation, the RFC 460R with IEC 61131 control system intelligence, redundancy technology, and network connection is the ideal solution. The integrated redundancy function based on fiber optics means that the process is not interrupted if one controller fails or is replaced. The RFC controllers are based on PROFINET and establish a redundant system automatically by means of AutoSync Technology.

i Web code: #2080



AutoSync Technology[®]
Designed by PHOENIX CONTACT

High-performance controller for IEC 61131-3



Redundant PROFINET PLC

RFC 460R PN 3TX Order No. [2700784](#)

- High availability with integrated PROFINET-based redundancy function
- Intel® Celeron® M ULV 423 processor
- 8 MB program memory
- 16 MB mass storage
- 120 kB non-volatile mass storage
- 2 independent network interfaces
- I/O points: max. 512 kb
- Programming with PC Worx

Reliable availability in a tunnel

The RFC 460R PN 3TX is used in tunnel applications where maximum availability must be ensured for a central control unit. This can be achieved, for example, by physically separating the redundancy system. A separate PLC is installed at each end of the tunnel. The controllers are synchronized via a FO connection. This means that if a dangerous situation

arises at one end of the tunnel, the other controller is not affected and takes over the reliable automation of the tunnel system.



Redundant control system for failsafe performance

A redundant control system consists of various levels. The most important level is the control level, which has access to the process. Here, two compact controllers are synchronized in such a way that one of them always controls the process. The OPC server ensures that the control level is always provided with data from the controller that is executing the process. The I/O components are connected via PROFINET for standardized usage of network redundancy protocols. In almost all cases, these require a ring topology.

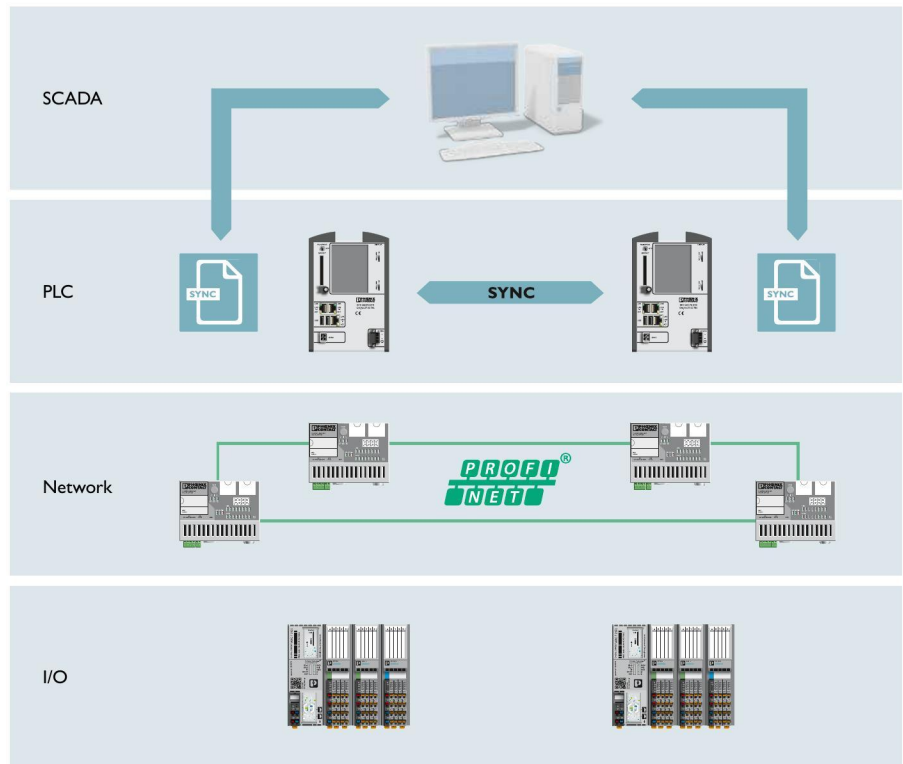

Modular automation system

Controllers, bus couplers, and I/O modules – Phoenix Contact provides an automation system for every requirement featuring a modular design. Benefit from the advantages of PLCnext Technology, conventional controllers or a remote I/O solution for various networks. Implement simple through to complex solutions using the diverse portfolio of I/Os.



Controllers

PLCs for high-level languages and IEC 61131-3 programming.

PLCnext Technology 
Designed by PHOENIX CONTACT

Bus couplers

Open to all common bus systems and network protocols.

Your advantages

- ✓ Scalable automation system for simple through to complex tasks
- ✓ Large selection of modules based on the modular principle
- ✓ Systemic configuration or connection to different networks using various front modules

COMPLETE line

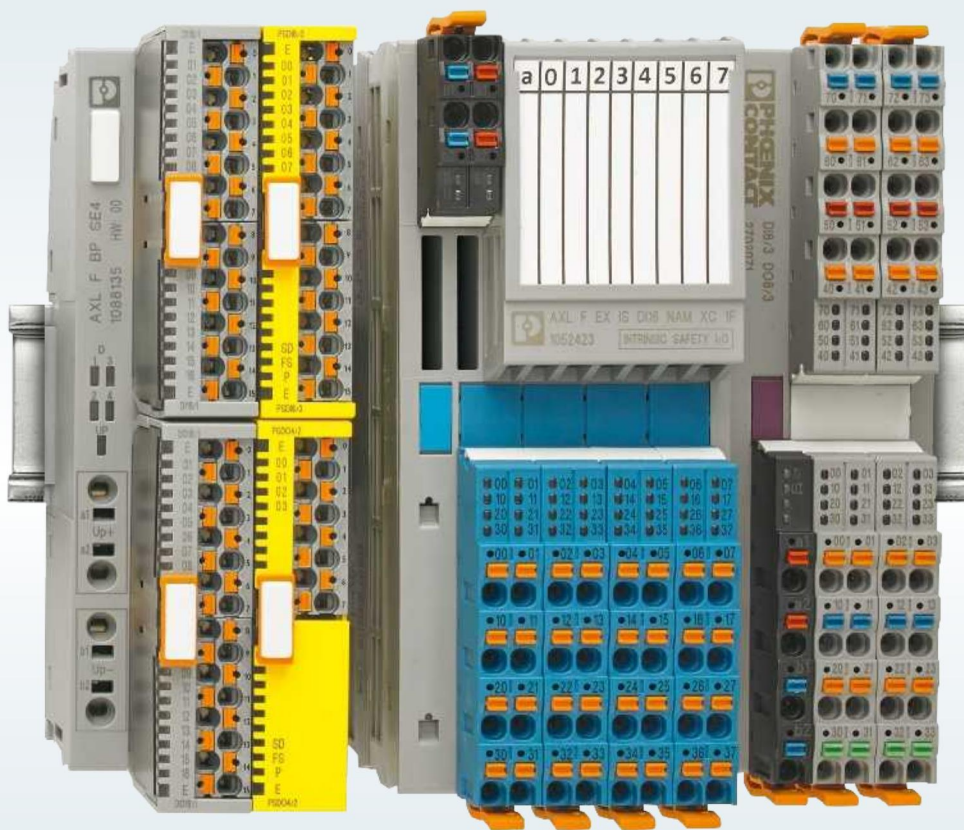

I/Os

Modules with digital and analog inputs and outputs, functions or for special applications.

Modular automation system

PLCnext Control devices for high-level languages and IEC 61131-3

PLCs for the open PLCnext Technology ecosystem are available in the form of PLCnext Control devices. They enable the implementation of automation projects without the limitations of proprietary systems. Benefit from the advantages of cloud integration or download software from the PLCnext Store onto your controller. PLCnext Control enables the parallel programming and combination of familiar programming languages, such as IEC 61131-3, C/C++, C# or MATLAB® Simulink®.

 Web code: #2108

PLCnext Technology 
Designed by PHOENIX CONTACT

PLCnext Control and extension options



For beginners

AXC F 1152

Order No. [1151412](#)

- ARM Cortex A9 single core, 800 MHz
- Up to 8 tasks
- Up to 16 PROFINET devices
- Up to 63 Axioline I/O modules can be aligned directly
- Trusted Platform Module (TPM) for security
- M2M system networking with OPC UA



Standard option

AXC F 2152

Order No. [2404267](#)

- ARM Cortex A9 dual core, 2x 800 MHz
- Up to 32 tasks
- Up to 64 PROFINET devices
- Up to 63 Axioline I/O modules
- Left-alignable interface extension (INTERBUS, PROFIBUS, Ethernet)
- Trusted Platform Module (TPM) for security
- M2M system networking with OPC UA



Higher performance

AXC F 3152

Order No. [1069208](#)

- Intel® Atom™ E3930 dual core, 2x 1.3 GHz
- Integrated UPS
- Up to 128 PROFINET devices
- Ready for time-sensitive networking
- Up to 63 Axioline I/O modules
- Left-alignable interface extension (INTERBUS, PROFIBUS, Ethernet)
- Trusted Platform Module (TPM) for security
- M2M system networking with OPC UA



(Retro-)fit for the future

Are you already using the Inline I/O system from Phoenix Contact for the automation of your systems and would you like to benefit from additional advantages in future by upgrading to the PLCnext Technology ecosystem? The Inline adapter terminal allows you to easily extend an existing I/O station with a PLCnext Control device, thereby enabling the successive modernization of an existing system.

For ordering information, see page 42 onwards



Easy expansion

Expand the functions of your PLCnext Control device with an Ethernet or INTERBUS module that can be aligned to the left of the controllers (AXC F 2152 or AXC F 3152). An additional Ethernet interface is available, otherwise the INTERBUS master can be used to integrate INTERBUS remote bus devices into the station.

For ordering information, see page 42 onwards

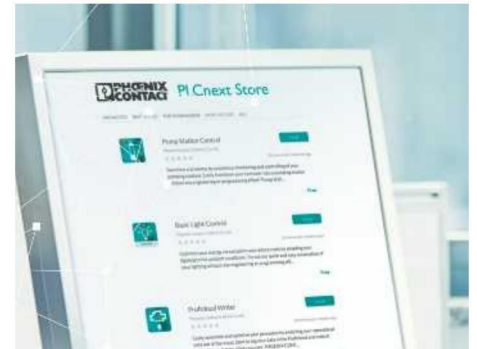

Benefit from digitalization

The PLCnext Store provides software applications (apps) that enable you to expand the functions of a PLCnext Control device directly and easily. Integrate open-source code from GitHub and discuss your project in the PLCnext Community. Direct integration into Proficloud enables you to implement intelligent communication, smart cloud services, and comprehensive data analysis – all with the highest level of security.

Modular automation system

PLCs for IEC 61131-3

Axioccontrol controllers are designed for maximum performance, easy handling, and use in harsh industrial environments. Their particularly robust housing and excellent EMC properties provide the basis for this.

Together with the Axioline F I/O system from Phoenix Contact, Axioccontrol offers maximum speed thanks to direct bus connection.

 Web code: #1148



Product overview and technical details



Standard PLC

AXC 1050
AXC 1050 XC

Order No. [2700988](#)
Order No. [2701295](#)

- Altera NIOS II processor
- 1 MB program memory
- 2 MB mass storage
- 48 kB non-volatile mass storage
- PROFINET controller
- 2 Ethernet interfaces and 1 Axioline F interface
- Extended temperature range with the XC version: -40°C ... +70°C
- Programming with PC Worx in accordance with IEC 61131-3

PLC with enhanced performance

AXC 3050

Order No. [2700989](#)

- Intel® Atom™ E660
- 4 MB program memory
- 8 MB mass storage
- 128 kB non-volatile mass storage
- 3 separate Ethernet interfaces and 1 Axioline F interface
- PROFINET controller
- Maritime approvals
- Programming with PC Worx in accordance with IEC 61131-3

Cloud IoT Gateway

For integrating new and existing systems without additional engineering effort. Through simple process connection using protocols such as Modbus/TCP, sensor and process data can be collected, processed, and monitored in Proficloud.

For ordering information, see page 41

Function blocks: Quick and easy controller expansion

Controllers from Phoenix Contact can be adapted to any requirement quickly and easily using SD cards and function blocks. This means that parameterization memories, licenses for function block libraries, and completely tested applications can be installed at a later time, without the need for additional hardware. Industry-specific function blocks are tailored to the individual requirements of a particular industry and offer considerable advantages when it comes to engineering. Furthermore, you benefit from straightforward device replacement by transferring the device data via SD card.

Integrate numerous functions into your system without programming effort, for example:

- IT functionality
- Remote control functions
- SQL connection
- Control technology
- Industry-specific solutions

All available function blocks can be found by entering the following web code into the search field on our website.

 **Web code: #1805**

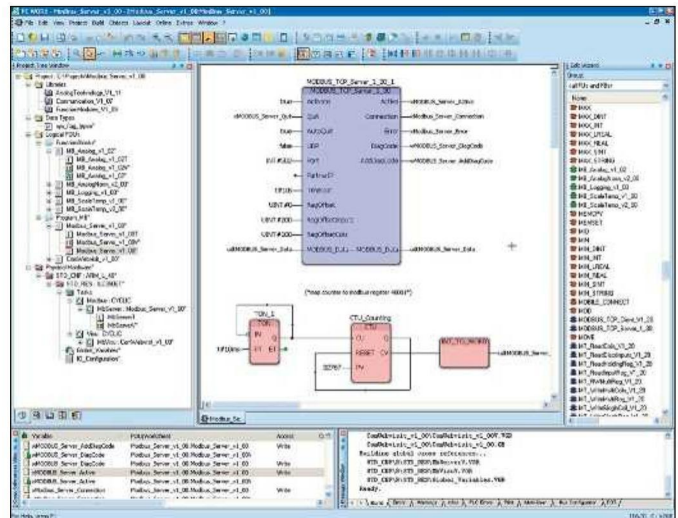

Modular automation system

Bus couplers for various networks

Use bus couplers from Phoenix Contact to integrate all the I/O modules of the modular automation system into your existing Ethernet network or bus system. The bus coupler opens up a local bus for up to 63 further devices and increases their variance and flexibility in the application configuration.

i Web code: #1149

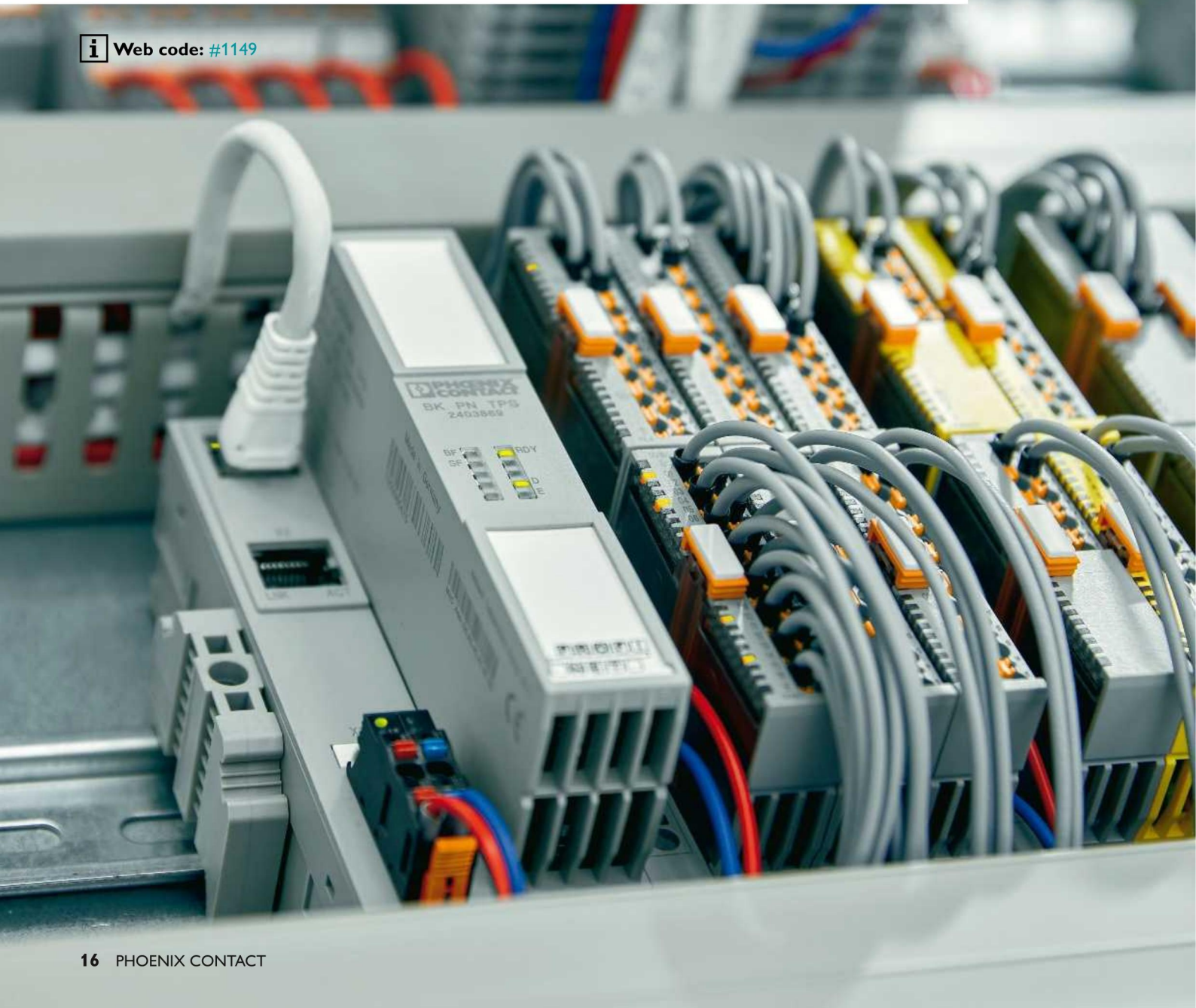

Bus couplers for various networks

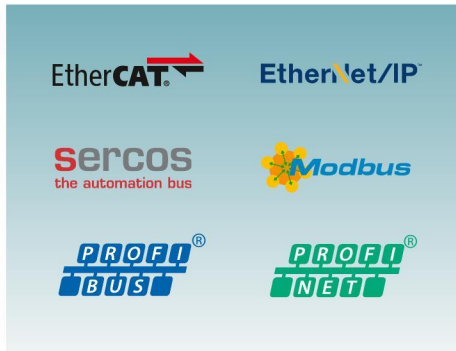

Optimum system connection

Axioline F is the Ethernet specialist for control cabinet installation. Alongside PROFIBUS DP, bus couplers are also available for today's leading Ethernet systems.

For ordering information, see page 42 onwards

PROFINET system redundancy

The AXL F BK PN TPS PROFINET bus coupler supports the specification for the implementation of S2 system redundancy using a single bus coupler. This means that the bus coupler can communicate with two redundant PROFINET controllers, thereby ensuring high systemic failsafe performance.

Easy offline parameterization

The Startup+ software is specifically designed for the Axioline F I/O system. Startup+ can be used, for example, to test the wiring of your Axioline station, without having to connect it to a network.

Greater variance with bus couplers

Safety in the system

Implement PROFI-safe solutions systemically in PROFINET networks. This can be easily done through the lower-level connection of PROFINET bus couplers with PROFI-safe I/O modules to Phoenix Contact controllers. You just need an engineering tool for programming and parameterization.

SafetyBridge Technology

Use Phoenix Contact bus couplers to integrate I/Os into all common Ethernet networks and bus systems. SafetyBridge Technology enables the network- and controller-independent implementation of safety applications. With this technology you can also transmit and

evaluate safety-related signals without the need for a safety controller.

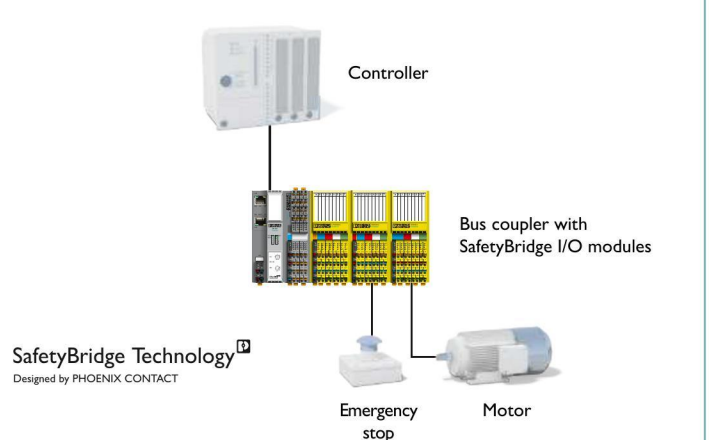
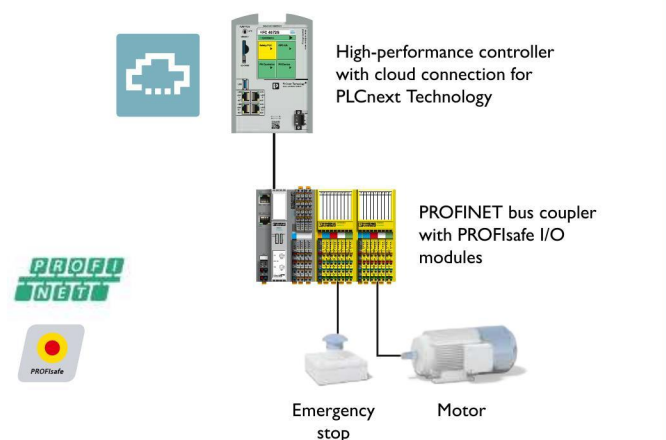

Modular automation system

Combine I/Os flexibly

Whether using any common bus system and network or a system-integrated controller – you can communicate quickly and cost-effectively thanks to advanced I/Os. The versatile IP20 range, which can be combined flexibly, provides reliable protection for your data and signal traffic, allowing you to design your systems for every possible area of application. Configure the transmission speed, functions, and structure in accordance with your requirements. Combine standard I/Os or use versions for extreme conditions as well as intrinsically safe modules.



The I/O modular system

Optimum automation solutions

With the Axioline I/O system with IP20 protection, automation solutions which optimally satisfy the relevant application requirements can be set up based on the modular principle. A bus coupler, which is available for various industrial Ethernet networks, or a distributed controller, such as the AXC F 2152 PLCnext Control device, acts as the head of the I/O station. At the station head, the user then connects the block modular I/O modules from the Axioline F product family as well as the Axioline Smart Elements, which can be assembled flexibly in a confined space.

In addition to digital and analog modules, the I/O portfolio also includes various function modules. Some Axioline F modules are also available in versions for very harsh ambient conditions. The appropriate I/O functions can be selected and the I/O station configured quickly and without errors using the Project+ software. The Axioline modular system is part of COMPLETE line, a system comprising coordinated hardware and software products, consulting services, and system solutions intended to optimize processes in control cabinet manufacturing.

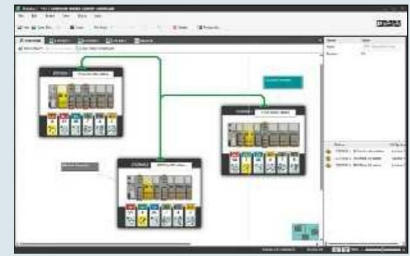

Configuration for I/Os

When it comes to configuring electrotechnical equipment for an automation application, Project+, the expert solution, is there to help. With no training required, you can create a functional station in accordance with your specifications very quickly with Project+. In addition, you can generate information for subsequent steps in the automation process.

Modularity in the system

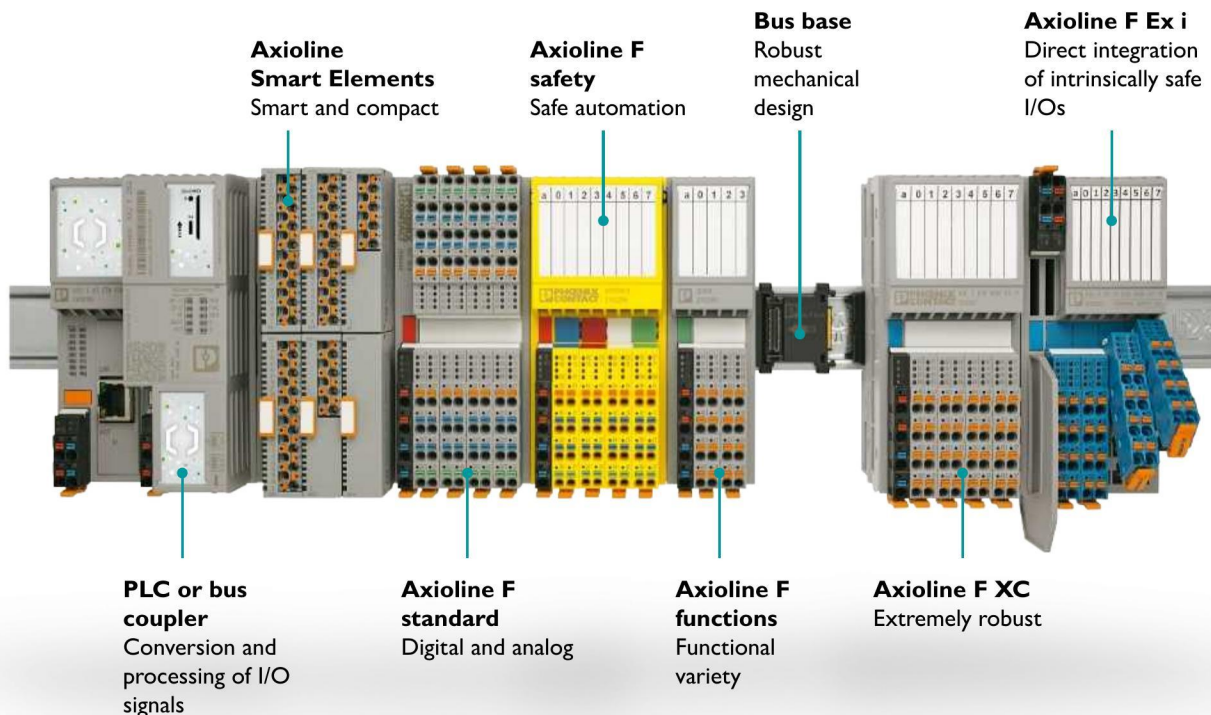

Axioline Smart Elements: Compact and flexible I/Os

Intelligent and cost-effective automation

The Axioline Smart Elements are compact, plug-in, and system-independent I/O elements. The Axioline Smart Elements feature very easy handling when it comes to configuration, installation, and startup.

The portfolio includes an IO-Link master, digital/analog input and output modules, safety modules for PROFI-safe, and further function modules.



Compact

An extremely compact housing design is achieved with 8 or 16 terminal points on a base area of 15 mm x 62 mm.

The large cable cross section of 1.5 mm² with ferrule including plastic collar with a pitch of 3.5 mm for I/O signals ensures a low voltage drop, even over longer cable lengths.



System-independent

Axioline Smart Elements do not have a local bus interface; they only feature I/O functionality. Communication with the relevant I/O system is only realized in conjunction with a carrier unit (backplane), which functions like an adapter. The Axioline Smart Elements are therefore universal and flexible to use.



Easy handling

Tool-free conductor connection with Push-in Technology reduces the installation time for signal lines. Minimize your startup time with Axioline Smart Elements, as they require little to no parameterization effort during startup or when replaced. The unlocking mechanism enables quick and easy mounting and removal.

Axioline Smart Elements in a modular automation system

32 channels within 15 mm in the Axioline F system

First and foremost, the Axioline Smart Elements can be used within an Axioline F station. Axioline F backplanes with four or six slots are available for this. The Axioline Smart Elements can be inserted at any point in the backplane. The two-row design of the backplane reduces the overall width of the I/O station considerably. This means that up to 32 channels and two different I/O functions can be implemented within 15 mm of space.

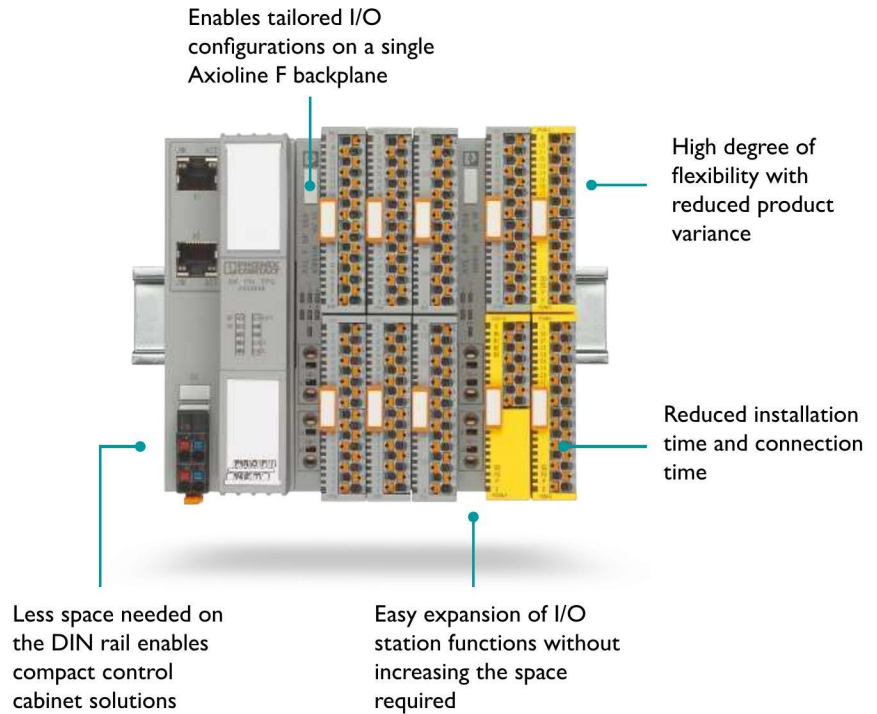

Compatibility of the Axioline Smart Elements

Within an I/O station, Axioline F modules and Axioline Smart Elements can be freely combined as desired. They can therefore be operated on existing Axioline F bus couplers or Axiocontrol devices

(PLCnext Control devices and conventional PLCs). Choose from a range of more than 80 I/Os, bus couplers, and control components.

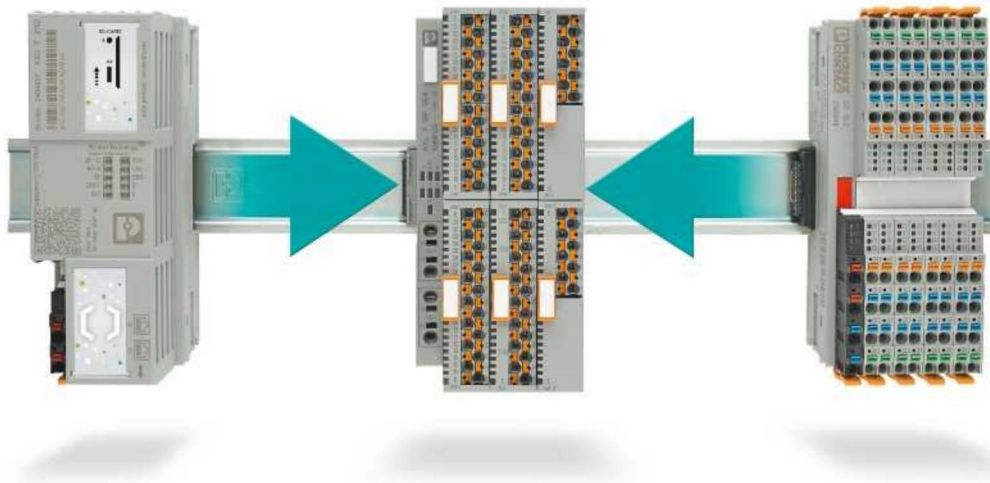

Axioline F: Standard I/O modules

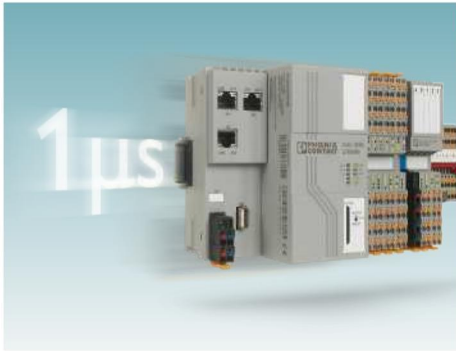

Optimum performance at all times

With an update time of 1 μs per I/O module in the local bus, Axioline F is as fast as parallel cabling – as such the higher-level bus system determines the speed.



Robust mechanical design

Thanks to its increased mechanical robustness, Axioline F has a vibration resistance of 5g, a continuous shock resistance of 10g, and a shock resistance of 30g.



Short installation times

Push-in connection technology shortens installation times. Clear wiring: the design supports cabling from above and below.

Functions for every application

Axioline F is a modular I/O system designed to meet every requirement. Fast and synchronous signal acquisition increases your machine output, whether with a Phoenix Contact controller or in all common networks with a corresponding bus coupler.

Axioline F offers a large range of I/O modules with digital and analog inputs and outputs, functions or for special applications. Implement safety applications with PROFI-safe or SafetyBridge Technology. The versatile I/O modules ensure flexibility in your station structure.



IEC 61850

SafetyBridge Technology[®]
Designed by PHOENIX CONTACT

IO-Link



Axioline F: I/O modules for special environments

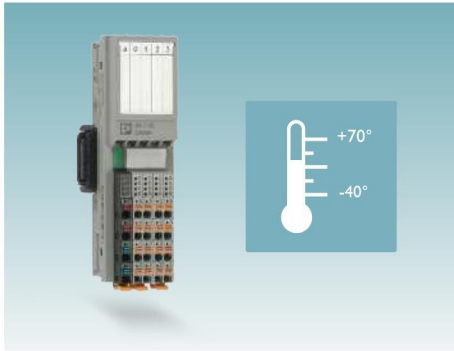

Extended temperature range

In harsh environments, reliable communication is essential. Axioline F features a particularly robust mechanical design. The XC versions with an extended operating temperature range from -40°C to +70°C and coated printed circuit boards are ideal for use under extreme conditions.



Approvals for marine automation

Due to their advantageous properties, the I/O modules have been approved by all major marine classification societies. With its low noise emission and robust mechanical design, Axioline F satisfies the stringent requirements for automation in shipbuilding.



Intrinsically safe I/Os

The intrinsically safe I/O modules can be installed in zone 2 and are suitable for the use of sensors and actuators up to zone 0. They feature HART communication and NAMUR functionality, making them particularly suitable for applications in process automation.

NAMUR Open Architecture

The NOA concept opens up new possibilities, enabling the data already available in process engineering systems to be used to optimize processes. Phoenix Contact has therefore also developed an I/O solution for the intrinsically safe area that allows the relevant information to be easily read by means of HART communication. This data can be transferred to a cloud solution (such as Proficloud from Phoenix Contact, Azure from Microsoft, etc.) as raw data or preprocessed by the PLCnext Technology ecosystem via the OPC UA server. When used in combination with PLCnext Technology, the Ex i modules of the Axioline F I/O system are the ideal solution for NOA applications involving the impact-free automation of ancillary processes.

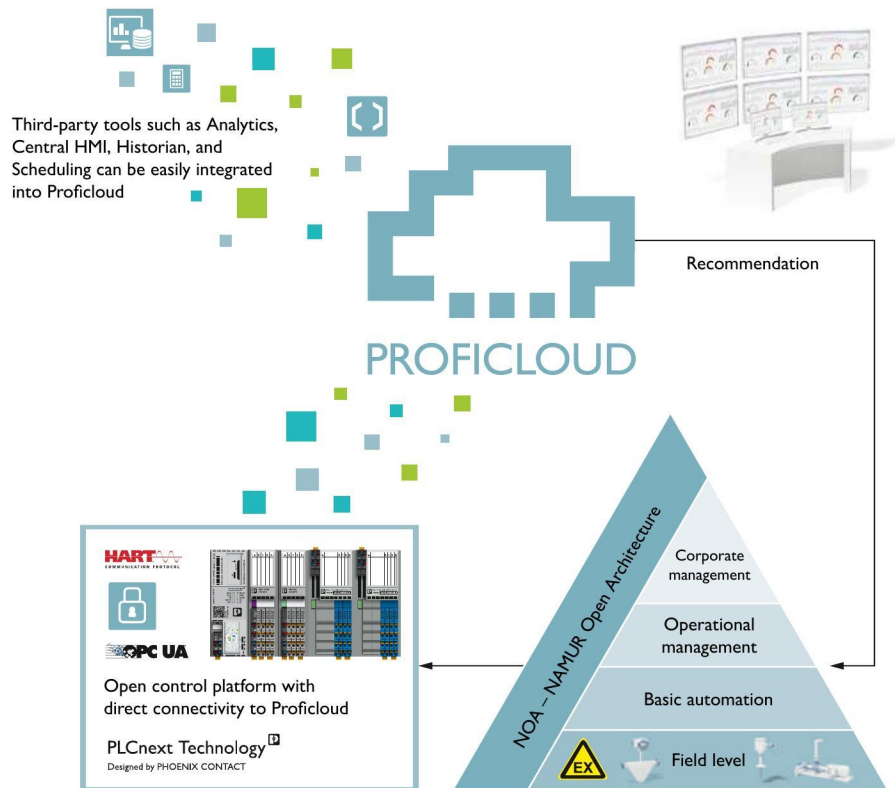

The right automation solution for every requirement

Open and future-proof

Digitalization, networking, and globalization are placing new demands on automation. Young engineers and software developers are shaping new working methodologies and cloud computing is enabling the creation of future-oriented industrial business models. When it comes to the development of automation solutions, in addition to standards such as IEC 61131, modern automation systems must also allow users to adopt new concepts and new methodologies, such as those encountered in IT applications. Along with their robust design, they are characterized by their flexibility, adaptability, and open networking options.



Flexible and compact

The amount of space needed for components installed in the control cabinet is becoming increasingly important. With the growing modularization of machinery, the use of the traditional control cabinet is on the decline. Instead, the devices are installed in small control cabinets that are integrated into the relevant machine modules. In addition, many machine variants require a high degree of flexibility with respect to the station structure and a wide range of function modules. If solutions are required for functional safety, not only do they need to be cost-effective, they must also satisfy the safety requirements up to SIL 3 or PL e.

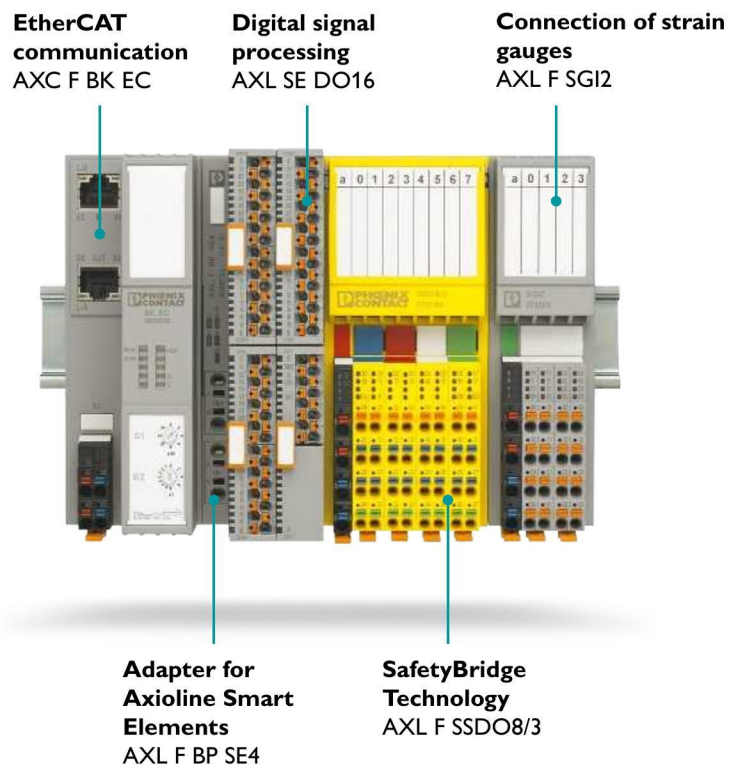
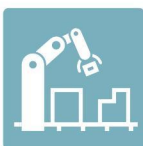

Digital and communicative

Autonomous ships will become a reality in the next few years and the topics of Industrie 4.0 and digitalization combined under the guise of "Maritime 4.0" have become increasingly important. The digitalization of ships in all service life phases requires new technologies and solutions that meet future requirements to operate ships more efficiently and digitally. Being able to retrofit and digitalize existing ships is also very important. In addition to standard signals, such as analog and digital signals, maritime and offshore applications also involve special types of data protocols which must be incorporated and processed.

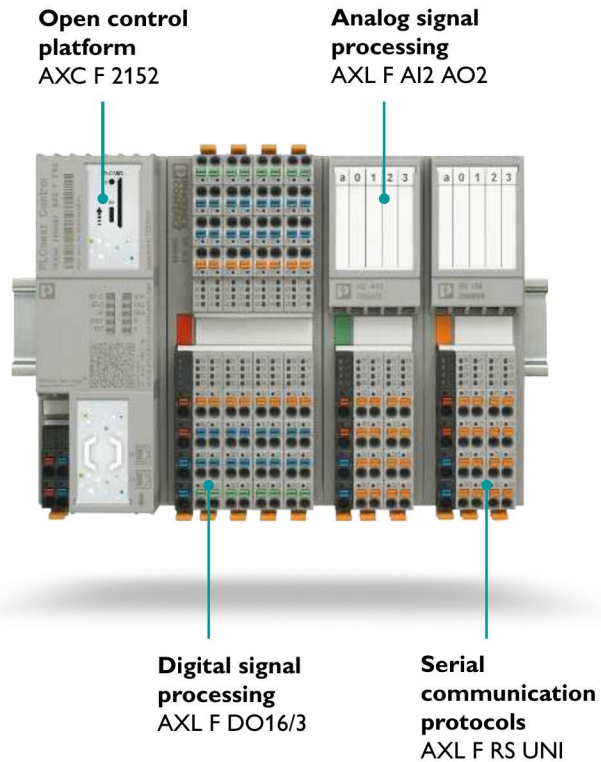

Robust and intrinsically safe

In the field of process technology and process engineering, system availability, modularization, and digitalization are key factors in keeping pace with increasing competition. Whether in the chemicals and pharmaceuticals industry or the oil and gas industry, highly complex process plants must satisfy the growing demands on system safety and flexibility, even under extreme conditions. Monitoring and optimization are becoming increasingly important in process automation. Here, in addition to important 4 ... 20 mA measuring signals, other types of data can be read via HART communication as a superimposed signal from the field devices – whether a sensor or an actuator.

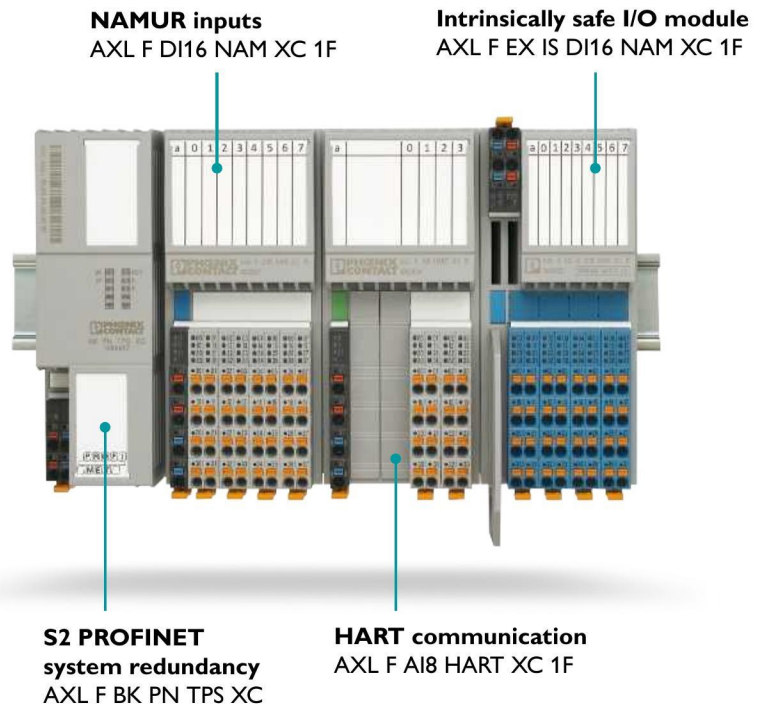

I/O system for field installation

Acquire input and output data directly in your systems and machines. Whether modular or compact, metal or plastic, Ethernet network or fieldbus system, Phoenix Contact offers a wide range of I/O devices with IP65/IP67 protection – suitable for every use.



Standard I/O devices

I/Os in two housing versions – choose between plastic or metal housing depending on the application.



IO-Link master

For the modular extension of the Axioline E I/O station.



Your advantages

- ✓ Superior mechanical robustness minimizes downtimes
- ✓ Wide temperature range from -25°C to +60°C extends the scope of possible applications
- ✓ Greater flexibility and wider range of functions with IO-Link communication



 **IO-Link**

IO-Link I/O boxes

Input devices for acquiring digital signals.



 **IO-Link**

IO-Link converters

The IO-Link/analog converters facilitate optimum analog signal acquisition by the simplest means possible.

I/O system for field installation

Distributed I/Os

Axioline E is the I/O system with a block design for field installation. Open to all Ethernet-based communication protocols and available in two housing versions, Axioline E provides maximum flexibility for your individual solution. Like all Axioline I/Os, Axioline E is also fast, robust, and easy.

 Web code: #1274



Product overview and technical details

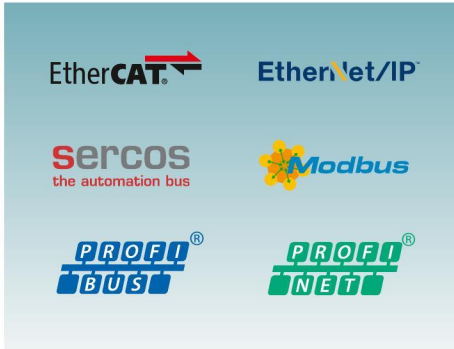

Variety of protocols

Whichever network you prefer – Axioline E offers the appropriate I/Os. This is because Axioline E is open to all Ethernet-based communication protocols and the PROFIBUS fieldbus system.

As well as various digital functions, the product portfolio also offers an IO-Link master for every network.

Variety of functions

Along with standard digital input and output functions, IO-Link devices increase the scope of functions of Axioline E devices. Acquire analog signals cost-effectively in the field or process safe inputs and outputs in SafetyBridge Technology and PROFSafe applications.

Robust

The Axioline E series devices with IP65/IP67 protection are characterized by their exceptional robustness. Thanks to their outstanding resistance to EMI and their robust mechanical design, they minimize downtimes.

Accessories for Axioline E

A comprehensive range of accessories and infrastructure components is available for field installation. For example, you have your choice of sensor/actuator cabling, connectors for assembly, and power and signal distributors.



Quick installation and easy handling

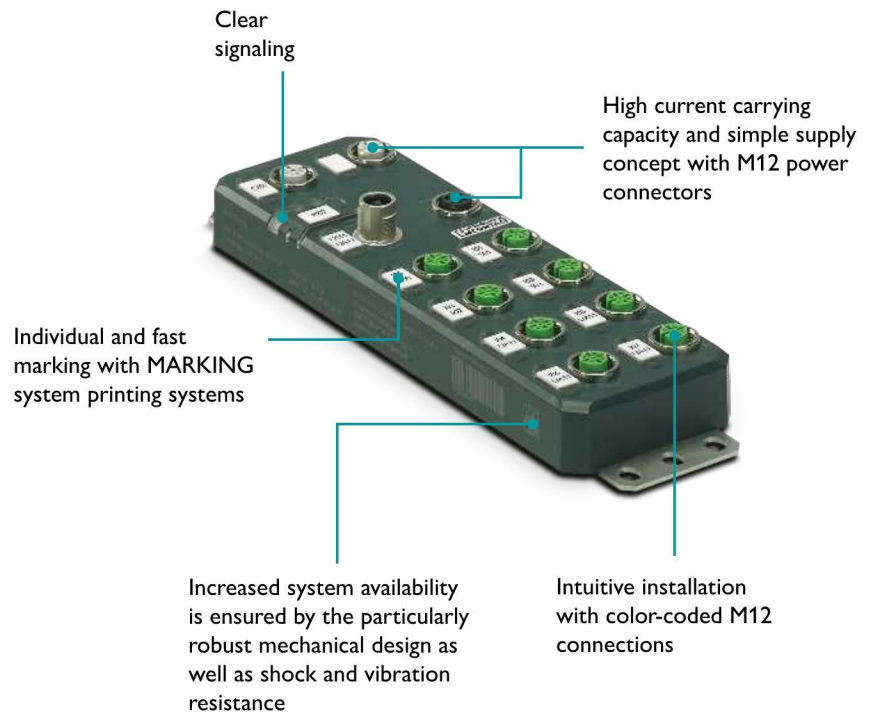

I/O system for field installation

IO-Link

IO-Link is currently the fastest growing communication standard in the field of industrial automation. The reason behind this dynamic growth is that it is standardized, open, and cost-effective.

To this end, Phoenix Contact offers a comprehensive IP20 and IP67 portfolio of IO-Link masters, IO-Link devices, cabling, and software. You can therefore ensure consistent communication right through to field level.

 Web code: #2074

 **IO-Link**

IP20 master with software

IO-Link master for the connection of IO-Link devices. Available for the Axioline F I/O system and as a stand-alone version.



Product overview and technical details



IO-Link master

Axioline E IO-Link master with eight IO-Link ports for all common network protocols in plastic or metal housing. The Axioline E series IO-link masters enable you to tailor the I/O configuration. This provides greater efficiency in the field, making the solution more cost-effective.



I/O boxes

The standard and safety I/O boxes are connected to an IO-Link master via an IO-Link A port. They are used to acquire digital signals via IO-Link. The IO-Link master enables use within different networks.



IO-Link converters

Converters in different designs enable the transmission of analog signals. The IO-Link/analog converters are connected directly to an analog sensor or positioned in the immediate vicinity. This greatly reduces or completely eliminates the need for shielded cables. As a result, particularly cost-effective analog communication in the field is possible.

Communication via IO-Link

IO-Link enables the standardized connection of switching devices, I/Os, and sensors to the control level. To exchange process data and acyclic data,

field devices can be integrated very easily and cost-effectively using point-to-point communication.

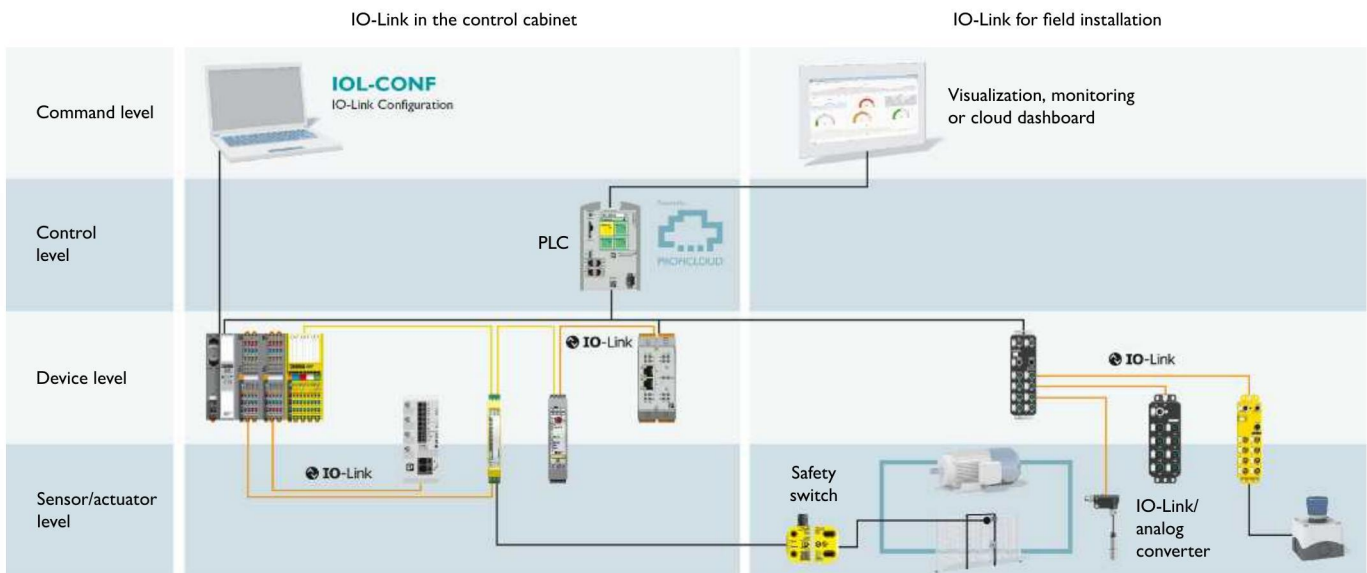

Engineering software for automation

To keep pace with the ever-growing demands placed on speed and flexibility in production, software has become a key factor in success in this age of digitalization.

Our interconnected software tools reduce your overall engineering effort and the intuitive user interfaces save time.

PLCnext Engineer Engineering Software

Software for PLCnext Control devices

PLCnext Engineer is the software platform for configuration, programming in accordance with IEC 61131-3, visualization, and diagnostics. In addition, this software also allows you to easily connect high-level language code to the standard application. PLCnext Engineer is the user-friendly engineering solution for your PLCnext Control devices.

You can now also accelerate your application development process with ready-to-use solutions and software blocks from the PLCnext Store: plcnextstore.com

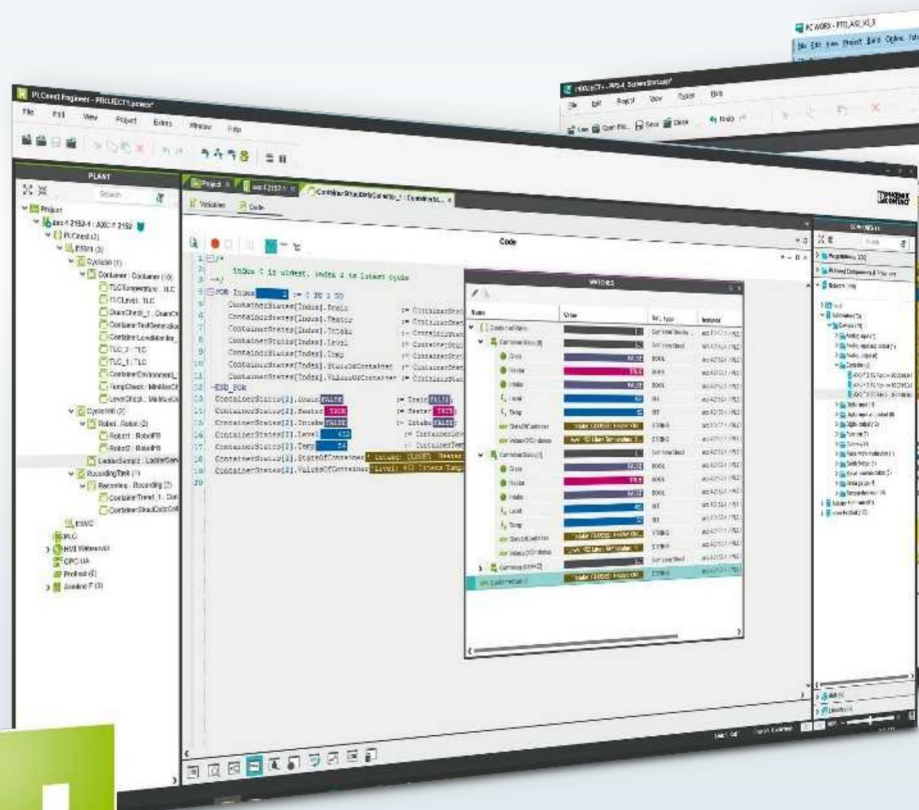

PROJECT+3
I/O Project Planning

PC WORX
PLC Programming

SAFETYPROG
Safety Programming

VISU+
SCADA Visualization

Software for the entire automation application

For all conventional controllers from Phoenix Contact, we offer PC Worx, our programming software in accordance with IEC 61131-3, which enables the quick and consistent implementation of complex automation concepts. Tools for the configuration of I/O stations as well as for visualization and safe programming also provide the ideal combination of hardware and software.

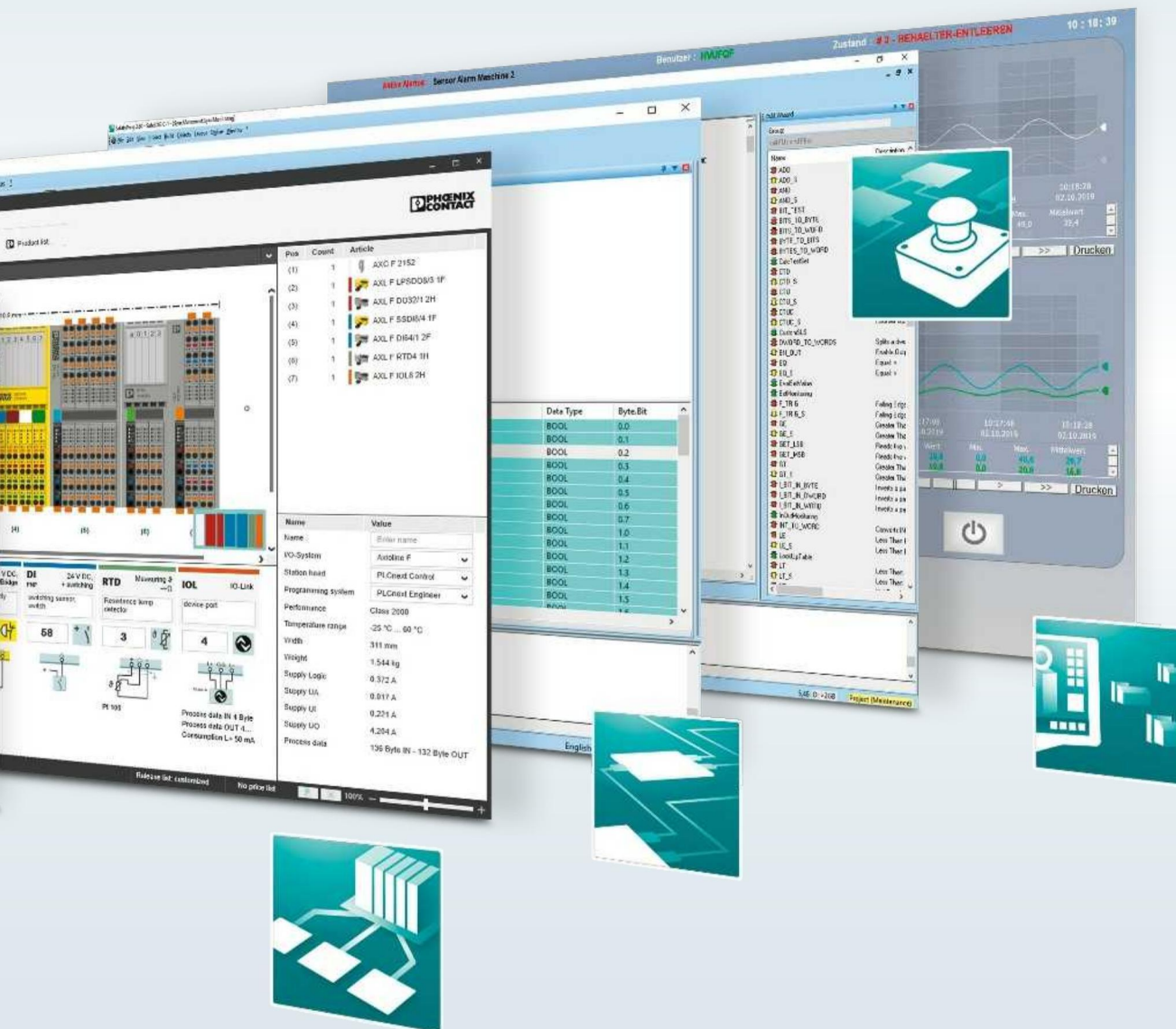

Engineering software for automation

PLCnext Engineer Software for PLCnext Control devices

The PLCnext Engineer software platform can be extended with add-ins, providing you with a free software tool for all engineering tasks associated with PLCnext Control. Fully integrated programming in a single interface saves a huge amount of time and money. The use of automation modules and object-oriented programming makes the engineering process much simpler.

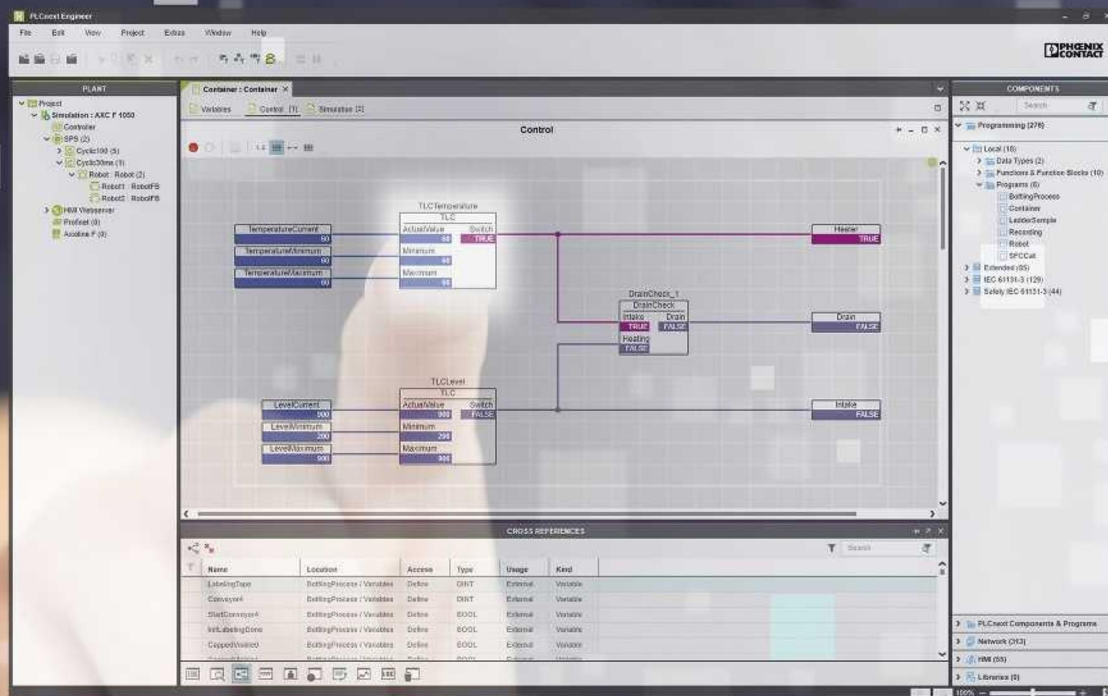

Free download of PLCnext Engineer

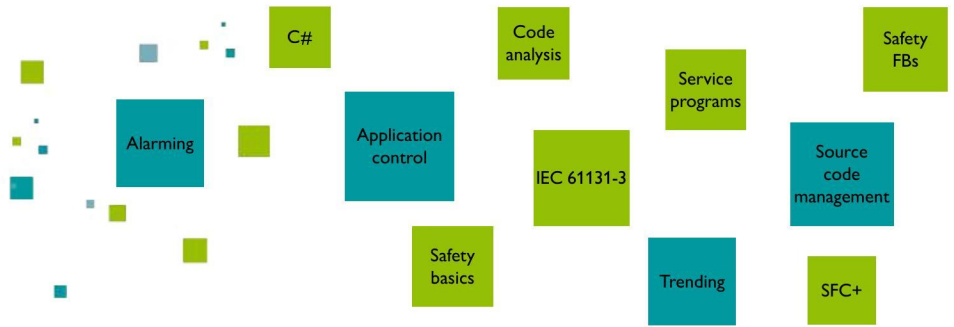
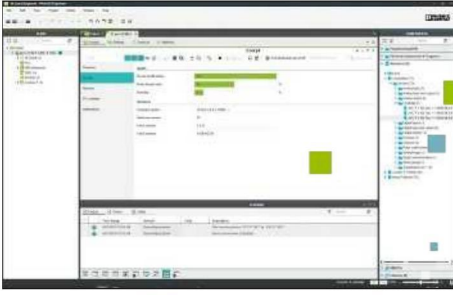

Implement and accelerate your entire engineering process with this software tool. Download the free version or add extra functions and interfaces in the form of optional add-ins. Create your custom PLCnext Engineer license on our website.

i Web code: #1710

Add-in Viewer for Simulink®

Viewer for displaying MATLAB® Simulink® models that can be processed on a PLCnext Control device with online values.

Add-in Sequential Function Chart Editor

Editor for programming the IEC 61131-3-compliant sequential function chart with integrated troubleshooting.

Add-in Application Control Interface

Interface for controlling the PLCnext Engineer software remotely from external high-level language applications.

Add-in Functional Safety Editor

This additional add-in is an editor that has been certified by TÜV Rheinland and enables the programming of safety-related applications as well as the configuration and startup of PROFI-safe devices. In safety technology, components must be easy to handle and safe to operate. With PLCnext Engineer, it is possible to perform both the standard PLC programming and the programming of all safety functions in one editor. The PLC and safety programming are then installed on the PLCnext Control device in one project. This extracts and automates the programs in two parts – the PLC code and the safety code.

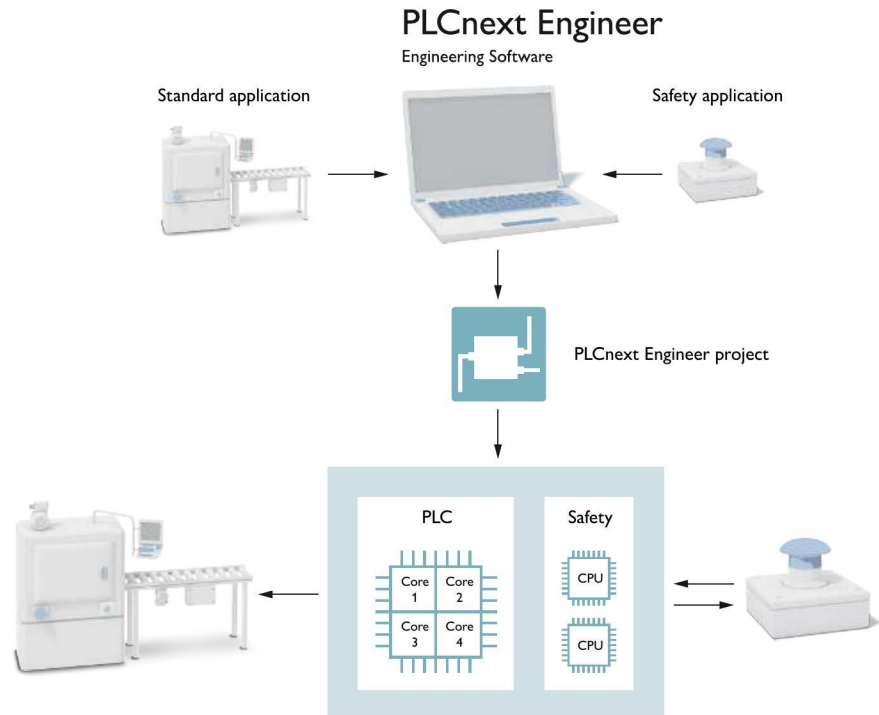

PLCnext Engineer – software for PLCnext Control devices

Programming in accordance with IEC 61131-3

The software enables intuitive programming in accordance with IEC 61131-3 and supports the following languages:

- Structured text (ST)
- Ladder diagram (LD)
- Function block diagram (FBD)
- Sequential function chart (SFC)

In the case of graphical programming languages, users can choose between network-oriented and free graphical programming, and can combine the various languages within Program Organization Units.

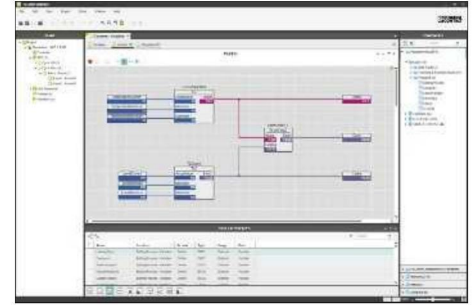

Safety programming

Safe programming has been developed in accordance with IEC 61508 and certified by TÜV Rheinland. Network-oriented editors allow users to use function block diagram or ladder diagram as a limited variability language (LVL) and to combine the two. A verification function can be used to protect individual safety functions.

The safe semantic code analysis that constantly runs in the background while code is being entered assists the user in positioning safety-related or standard signals and blocks.

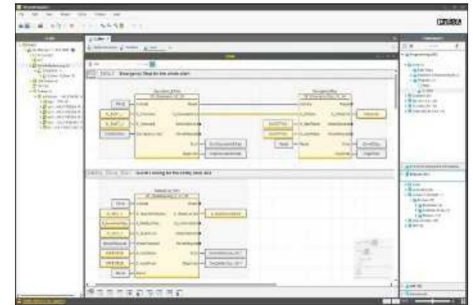

Web-based visualization

PLCnext Engineer has been optimized for the creation of modern visualization solutions. Already familiar operating concepts from other editors make it easier to get started. With respect to the technology, the visualization integrated into PLCnext Engineer is based on open standards such as HTML5 and JavaScript.

No web-based skills are required, the software offers numerous symbols and templates and can be extended as necessary to suit your needs.



Diagnostics of the overall system

From the central controller cockpit, users can determine the status of their overall application. They can determine whether enough reserves are present or whether limits have already been exceeded.

PROFINET topology plans are checked online and errors or differences in the diagnostic archive of the controller cockpit are displayed.

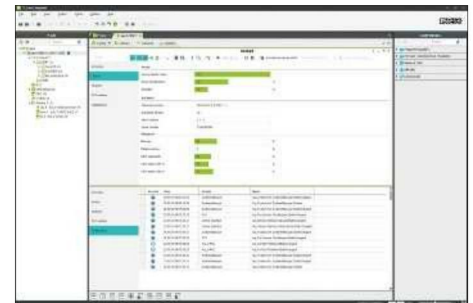

The open world of automation programming

The flexible engineering tool is more than an all-in-one tool for conventional programming, which combines all the essential functions for the engineering process in one software: it also provides convenient handling when connecting high-level language programs and the standard automation.

With PLCnext Engineer, we make it easy for you to configure your PROFINET networks, run high-level language programs or MATLAB® Simulink® models, and start up and manage these on a PLCnext Control device.

All variables and interfaces can be linked via the data lists, for example, in order to directly connect physical inputs and outputs to high-level language code and to exchange data.

As a result, the startup and maintenance of highly complex systems without any IEC 61131-3 code is also greatly simplified with PLCnext Engineer.

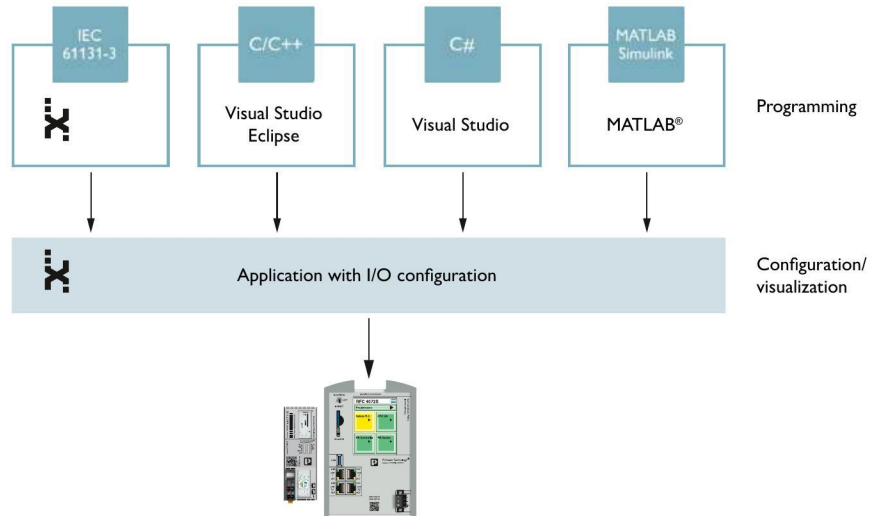

Become a part of the PLCnext Community

Along with a future-oriented system of hardware, software, and cloud solutions, users of the ecosystem also benefit from a growing community involved in all aspects of PLCnext Technology. Dialog with users is becoming increasingly important, and having access to specialists as well as a wide range of apps, code, and sample programs is a major advantage for programmers. The PLCnext Community provides information on all aspects of PLCnext Technology. For example, discover application examples, instructions for use, further instructions, tutorials, training videos, and FAQs, as well as software and firmware downloads. Use our GitHub forum or the technical help available on YouTube.

Become a part of the user community. Discuss your personal experiences with PLCnext Technology with other users. We look forward to your ideas and your feedback.

Join the community – become a part of PLCnext Technology

plcnext-community.net

#plcnext #iamplcnext



Engineering software for automation

Software for the entire automation application

Phoenix Contact provides a wide range of coordinated software tools for the entire engineering process. From planning and configuration through programming to system startup, our portfolio offers intuitive software products that are sure to impress.



Overview of software tools

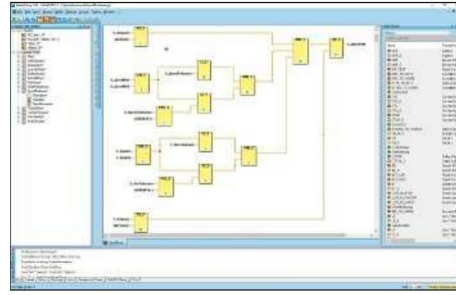
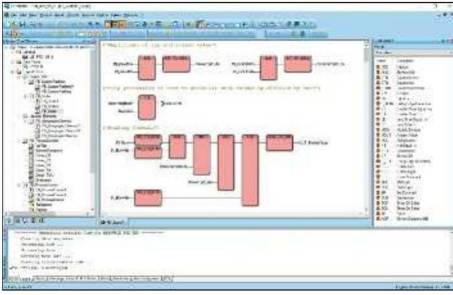

PC Worx programming software

- Programming software in accordance with IEC 61131-3
- Fieldbus configuration for INTERBUS, PROFINET, and Modbus, as well as system diagnostics
- Numerous programming languages supported: IL, FBD, LD, ST, SFC, FFLD
- Free Express version available for entry-level users

i Web code: #1163

SafetyProg safe programming software

- Safe programming software for INTERBUS-Safety systems and PROFIsafe controllers from Phoenix Contact
- With graphical user interface in accordance with IEC 61131-3 in function block diagram (FBD), ladder diagram (LD), and structured text (ST)
- Meets the safety requirements defined in IEC 61508

i Web code: #1976

Project+ 3 configuration software

- Configuration software for fast I/O station planning
- Easily create custom I/O stations that are technically correct
- The signal requirements and structure plan at a glance

i Web code: #1161

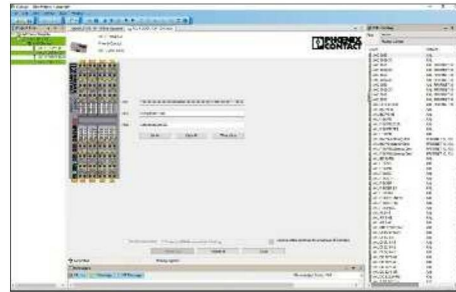

Visu+ visualization software

- Creation of sophisticated graphical user interfaces
- Full SCADA functionality provides trend display, alarm management, and data logging
- Connection to numerous control systems with preinstalled drivers
- For Windows PCs as well as embedded platforms (Windows CE), plus HMIs and industrial PCs from Phoenix Contact

i Web code: #1298

Startup+ parameterization software

- Easily check the wiring of the Axioline I/O station
- Parameterization of the I/O modules used
- Comprehensive diagnostics during operation
- Enables connection to a TCI interface

i Web code: #1164

Ordering overview: High-performance controllers and software



IP20

Note:

Our current and complete range of high-performance controllers, and all associated technical data, can be found on our website.

Type	Designation	Order No.
High-performance controllers		
PLCnext Control safety controller	RFC 4072S	1051328
Safety controller in accordance with IEC 61131-3	RFC 480S	2404577
Redundant PLC for IEC 61131-3, 2 network interfaces	RFC 460R PN 3TX	2700784
Redundant PLC for IEC 61131-3, 3 network interfaces	RFC 460R PN 3TX-S	1096407



Note:

Our current and complete range of software, and all associated technical data, can be found on our website.

Type	Designation	Order No.
Software		
Software for PLCnext Control devices	PLCnext Engineer	1046008
Programming software for PLCs for IEC 61131-3	PC Worx Basic LIC	2985275
Programming software for PLCs for IEC 61131-3	PC Worx Express	2988670
Programming software for functional safety	SafetyProg Basic	2700443
Visualization software	Visu+ 2	2988544
Configuration software for I/Os	Project+ 3	2988667
Parameterization software for I/Os	Startup+	2700636

Modular automation system



IP20

Note:

Our current and complete range of Axioline F products, and all associated technical data, can be found on our website.

Type	Designation	Order No.
PLCnext Control devices for high-level languages and IEC 61131-3		
PLCnext Control – for beginners	AXC F 1152	1151412
PLCnext Control – standard option	AXC F 2152	2404267
PLCnext Control – higher performance	AXC F 3152	1069208
Starter kit 2152 + AXL F	AXC F 2152 STARTERKIT	1046568
Starter kit 1152 + AXL SE	AXC F 1152 STARTERKIT	1167541
PLCnext Control Ethernet extension	AXC F XT ETH 1 TX	2403115
PLCnext Control INTERBUS master extension	AXC F XT IB	2403018
Adapter terminal for Inline I/Os	AXC F IL ADAPT	1020304
PLCs for IEC 61131-3		
Small-scale controller	AXC 1050	2700988
Small-scale controller with extended temperature range	AXC 1050 XC	2701295
Controller with higher performance	AXC 3050	2700989
Gateway for Proficloud	CLOUD IOT GATEWAY	1031235
Bus couplers for various networks		
Bus coupler for PROFINET	AXL F BK PN TPS	2403869
Bus coupler for PROFINET, for extended temperature range	AXL F BK PN TPS XC	1068857
Bus coupler for EtherCAT®	AXL F BK EC	2688899
Bus coupler for EtherNet/IP	AXL F BK EIP	2688394
Bus coupler for EtherNet/IP, with extended functionality	AXL F BK EIP EF	2702782
Bus coupler for Sercos	AXL F BK S3	2701686
Bus coupler for Modbus/TCP	AXL F BK ETH	2688459
Bus coupler for Modbus/TCP, for extended temperature range	AXL F BK ETH XC	2701949
Bus coupler for Modbus/TCP, with two independent network ports	AXL F BK ETH NET2	2702177
Bus coupler for Ethernet (IEC 61850)	AXL F BK SAS	2701457
Bus coupler for PROFIBUS	AXL F BK PB	2688530
Bus coupler for PROFIBUS, for extended temperature range	AXL F BK PB XC	2702463

Modular automation system

Type	Designation	Order No.
Combine I/Os flexibly		
Axioline Smart Elements		
Digital input module, 16 channels, 1-conductor	AXL SE DI16/1	1088127
Digital output module, 16 channels, 1-conductor	AXL SE DO16/1	1088129
Safe digital input module, 8 channels (PROFIsafe), 1-channel	AXL SE PSDI8/3	1079241
Safe digital output module, 4 channels (PROFIsafe), 1-channel	AXL SE PSDO 4/2 2A	1079231
Analog input module, 4 channels, 4 ... 20 mA, single ended	AXL SE AI4 I 4-20	1088062
Analog input module, 4 channels, 0 ... 10 V, single ended	AXL SE AI4 U 0-10	1088104
Analog output module, 4 channels, 4 ... 20 mA, single ended	AXL SE AO4 I 4-20	1088123
Analog output module, 4 channels, 0 ... 10 V, single ended	AXL SE AO4 U 0-10	1088126
Temperature measurement module, 4 channels for connecting resistance temperature detectors (RTDs)	AXL SE RTD4 PT100	1088106
Communication module, IO-Link master, 4 channels	AXL SE IOL4	1088132
Communication module, RS-485 serial interface	AXL SE RS485	1088128
Function module, counter input for 24 V sensors	AXL SE CNT1	1088131
Function module, symmetrical incremental encoder	AXL SE INC1 SYM	1088130
Module for covering unused backplane slots	AXL SE SC-A	1088134
Backplane, for accommodating 4 Axioline Smart Elements	AXL F BP SE4	1088135
Backplane, for accommodating 6 Axioline Smart Elements	AXL F BP SE6	1088136
Axioline F: Standard I/O modules		
Digital input module, 8 channels, 2-conductor, 24 V DC	AXL F DI8/2 24DC 1F	2702783
Digital input module, 8 channels, 2-conductor, 48, 60 V	AXL F DI8/2 48/60DC 1F	2702654
Digital input module, 8 channels, 2-conductor, 110 V DC	AXL F DI8/2 110/220DC 1F	2700684
Digital input module, 16 channels, 1-conductor, 24 V DC	AXL F DI16/1 1H	2688310
Digital input module, 16 channels, 1-conductor, 24 V DC, with fast inputs	AXL F DI16/1 HS 1H	2701722
Digital input module, 16 channels, 4-conductor, 24 V DC	AXL F DI16/4 2F	2688022
Digital input module, 32 channels, 1-conductor, 24 V DC	AXL F DI32/1 2H	2702052
Digital input module, 32 channels, 1-conductor, 24 V DC	AXL F DI32/1 1F	2688035
Digital input module, 64 channels, 1-conductor, 24 V DC	AXL F DI64/1 2F	2701450
Safe digital input module, 8 channels (PROFIsafe), 1-channel	AXL F PSDI8/4 1F	2701559
Safe digital input module, 8 channels (SafetyBridge Technology), 1-channel	AXL F SSDI8/4 1F	2702263
Digital output module, 4 channels, 3-conductor, 24 V DC	AXL F DO4/3 AC 1F	2702068
Digital output module, 4 channels, 2-conductor, 24 V DC	AXL F DOR4/2 AC/220DC 1F	2700608
Digital output module, 8 channels, 2-conductor, 24 V DC	AXL F DO8/2 2A 1H	2688381
Digital output module, 16 channels, 1-conductor, 24 V DC	AXL F DO16/1 1H	2688349
Digital output module, 16 channels, 1-conductor, 24 V DC, with FLK connection	AXL F DO16 FLK 1H	2701813
Digital output module, 16 channels, 2-conductor, 24 V DC	AXL F DO16/2 2H	1027904
Digital output module, 16 channels, 3-conductor, 24 V DC	AXL F DO16/3 2F	2688048
Digital output module, 32 channels, 1-conductor, 24 V DC	AXL F DO32/1 1F	2688051

Type	Designation	Order No.
Combine I/Os flexibly		
Axioline F: Standard I/O modules		
Digital output module, 32 channels, 1-conductor, 24 V DC	AXL F DO32/1 2H	1004925
Digital output module, 64 channels, 1-conductor, 24 V DC	AXL F DO64/1 2F	2702053
Safe digital output module, 8 channels (PROFIsafe), 1-channel	AXL F PSDO8/3 1F	2701560
Safe digital output module, 8 channels (SafetyBridge Technology), 1-channel	AXL F SSDO8/3 1F	2702264
Safe digital output module, 8 channels (SafetyBridge Technology), 1-channel with integrated safety logic	AXL F LPDO8/3 1F	2702171
Digital I/O module, 8 channels each, 1-conductor, 24 V DC	AXL F DI8/1 DO8/1 1H	2701916
Digital I/O module, 8 channels each, 3-conductor, 24 V DC	AXL F DI8/3 DO8/3 2H	2702071
Digital I/O module, 16 channels each, 3-conductor, 24 V DC	AXL F DI16/1 DO16/1 2H	2702106
Digital I/O module, 16 channels (input), 1-conductor, 8 channels (output), 2-conductor, 24 V DC	AXL F DI16/1 DO8/2-2A 2H	2702291
Analog input module, 4 channels, current, configurable current ranges	AXL F AI4 I 1H	2688491
Analog input module, 4 channels, voltage, configurable voltage ranges	AXL F AI4 U 1H	2688501
Analog input module, 8 channels, current/voltage, configurable current and voltage ranges	AXL F AI8 1F	2688064
Analog I/O module, 2 channels each, current/voltage, configurable current and voltage ranges	AXL F AI2 AO2 1H	2702072
Analog output module, 4 channels, current/voltage, configurable current and voltage ranges	AXL F AO4 1H	2688527
Analog output module, 8 channels, current/voltage, configurable current and voltage ranges	AXL F AO8 1F	2688080
Temperature measurement module, 4 channels for connecting resistance temperature detectors (RTDs)	AXL F RTD4 1H	2688556
Temperature measurement module, 8 channels for connecting resistance temperature detectors (RTDs)	AXL F RTD8 1F	2688077
Temperature measurement module, 8 channels for connecting resistance temperature detectors (RTDs) with high dynamic range	AXL F RTD8 S 1F	2702120
Temperature measurement module, 4 channels for connecting thermocouples	AXL F UTH4 1H	2688598
Temperature measurement module, 8 channels for connecting thermocouples	AXL F UTH8 1F	2688417
Function module, 2 counter inputs for 24 V signals, 2 incremental encoder inputs, 8 digital inputs	AXL F CNT2 INC2 1F	2688093
Communication module, serial interface, parameterizable	AXL F RS UNI 1H	2688666
Communication module, IO-Link master, 8 channels	AXL F IOL8 2H	1027843
DALI master, 2 channels, integrated DALI power supply unit	AXL F MA DALI2 1H	2702864
M-Bus master, for connecting M-Bus meters in accordance with EN 13757-2	AXL F MA MBUS 1H	1104545
Function module, 1 SSI interface for absolute encoder, 1 analog output	AXL F SSI1 AO1 1H	2688433
Function module, pulse width modulation	AXL F PWM2 1H	1007352
Strain gauge capture module	AXL F SGI2 1H	2702911
Power measurement module, voltage and current measurements	AXL F PM EF 1F	2702671
Power module for the communications power UBus	AXL F PWR 1H	2688297

Modular automation system

Type	Designation	Order No.
Combine I/Os flexibly		
Axioline F: I/O modules for extreme environments		
Digital input module, 16 channels, 4-conductor, extended temperature range	AXL F DI16/4 XC 2F	2701224
Digital input module, 16 channels, NAMUR, extended temperature range	AXL F DI16 NAM XC 1F	1052427*
Digital input module, 16 channels, NAMUR, intrinsically safe, extended temperature range	AXL F EX IS DI16 NAM XC 1F	1052423*
Digital input module, 32 channels, 1-conductor, extended temperature range	AXL F DI32/1 XC 1F	2701226
Digital output module, 4 channels, 24 ... 48 V DC, intrinsically safe, extended temperature range	AXL F EX IS DO4 SD 24-48 XC 1F	1086901*
Digital output module, 4 channels, 21 ... 60 V DC, intrinsically safe, extended temperature range	AXL F EX IS DO4 SD 21-60 XC 1F	1086902*
Digital output module, 8 channels, 2-conductor, extended temperature range	AXL F DO8/2 2A XC 1H	1035427
Digital output module, 16 channels, 3-conductor, extended temperature range	AXL F DO16/3 XC 2F	2701228
Digital output module, 32 channels, 1-conductor, extended temperature range	AXL F DO32/1 XC 1F	2701230
Digital I/O module, 8 channels each, 1-conductor, 24 V DC, extended temperature range	AXL F DI8/1 DO8/1 XC 1H	2702017
Analog input module, 4 channels, current, configurable current ranges, extended temperature range	AXL F AI4 I XC 1H	2702007
Analog input module, 4 channels, voltage, configurable voltage ranges, extended temperature range	AXL F AI4 U XC 1H	2702008
Analog input module, 8 channels, current/voltage, configurable current and voltage ranges, extended temperature range	AXL F AI8 XC 1F	2701232
Analog input module, 8 channels, HART, extended temperature range	AXL F AI8 HART XC 1F	1052434*
Analog input module, 8 channels, HART, intrinsically safe, extended temperature range	AXL F EX IS AI8 HART XC 1F	1052432*
Analog output module, 4 channels, current/voltage, configurable current and voltage ranges, extended temperature range	AXL F AO4 XC 1H	2702153
Analog output module, 4 channels, HART, extended temperature range	AXL F AO4 HART XC 1F	1087080*
Analog output module, 4 channels, HART, intrinsically safe, extended temperature range	AXL F EX IS AO4 HART XC 1F	1087081*
Analog output module, 8 channels, current/voltage, configurable current and voltage ranges, extended temperature range	AXL F AO8 XC 1F	2701237
Analog I/O module, 2 channels each, current/voltage, configurable current and voltage ranges, extended temperature range	AXL F AI2 AO2 XC 1H	1035429
Temperature measurement module, 4 channels for connecting resistance temperature detectors (RTDs), extended temperature range	AXL F RTD4 XC 1H	1035430
Temperature measurement module, 8 channels for connecting resistance temperature detectors (RTDs), extended temperature range	AXL F RTD8 XC 1F	2701235
Temperature measurement module, 8 channels for connecting thermocouples, extended temperature range	AXL F UTH8 XC 1F	2702464
Function module, 2 counter inputs for 24 V signals, 2 incremental encoder inputs, 8 digital inputs, extended temperature range	AXL F CNT2 INC2 XC 1F	2701239
Communication module for serial data transmission, 1 interface can be parameterized as RS-485/RS-422 or RS-232, extended temperature range	AXL F RS UNI XC 1H	2702006
Function module, 2 digital pulse interfaces for evaluating magnetostrictive position sensors with start/stop interface, for extended temperature range	AXL F IMPULSE2 XC 1H	2702655

* Products available from HMI 2020

Type	Designation	Order No.
Combine I/Os flexibly		
Accessories		
Shield connection	AXL SHIELD SET	2700518
Bus base module for bus couplers	AXL BS BK	2701422
Bus base module for housing type F	AXL F BS F	2688129
Bus base module for housing type H	AXL F BS H	2700992
Protective cap for the lateral contacts of Axioline F bus base modules	AXL F BS CAP	2702275
Partition plate for connecting intrinsically safe Axioline F and Axioline P I/Os	AXL F/P IO EX PP	1100201

I/O system for field installation



Note:

Our current and complete range of Axioline P products, and all associated technical data, can be found on our website.

Type	Designation	Order No.
Axioline E: Standard I/O devices		
Standard I/O device, digital input, 16 channels, metal, EtherCAT®	AXL E EC DI16 M12 6M	2701526
Standard I/O device, digital input, 16 channels, plastic, EtherCAT®	AXL E EC DI16 M12 6P	2701521
Standard I/O device, digital input/output, 12 channels, metal, EtherCAT®	AXL E EC DI8 DO4 2A M12 6M	2701529
Standard I/O device, digital input/output, 12 channels, plastic, EtherCAT®	AXL E EC DI8 DO4 2A M12 6P	2701523
Standard I/O device, digital input/output, 16 channels, metal, EtherCAT®	AXL E EC DI8 DO8 M12 6M	2701525
Standard I/O device, digital input/output, 16 channels, plastic, EtherCAT®	AXL E EC DI8 DO8 M12 6P	2701520
Standard I/O device, digital input/output, 16 channels, metal, EtherCAT®	AXL E EC DIO16 M12 6M	2701528
Standard I/O device, digital input/output, 16 channels, plastic, EtherCAT®	AXL E EC DIO16 M12 6P	2701522
Standard I/O device, digital input, 16 channels, metal, EtherNet/IP	AXL E EIP DI16 M12 6M	2701488
Standard I/O device, digital input, 16 channels, plastic, EtherNet/IP	AXL E EIP DI16 M12 6P	2701493
Standard I/O device, digital input/output, 12 channels, metal, EtherNet/IP	AXL E EIP DI8 DO4 2A M12 6M	2701490
Standard I/O device, digital input/output, 12 channels, plastic, EtherNet/IP	AXL E EIP DI8 DO4 2A M12 6P	2701495
Standard I/O device, digital input/output, 16 channels, metal, EtherNet/IP	AXL E EIP DI8 DO8 M12 6M	2701487
Standard I/O device, digital input/output, 16 channels, plastic, EtherNet/IP	AXL E EIP DI8 DO8 M12 6P	2701492
Standard I/O device, digital input/output, 16 channels, metal, EtherNet/IP	AXL E EIP DIO16 M12 6M	2701489
Standard I/O device, digital input/output, 16 channels, plastic, EtherNet/IP	AXL E EIP DIO16 M12 6P	2701494
Standard I/O device, digital input, 16 channels, plastic, Ethernet	AXL E ETH DI16 M12 6P	2701533
Standard I/O device, digital input/output, 12 channels, plastic, Ethernet	AXL E ETH DI8 DO4 2A M12 6P	2701535
Standard I/O device, digital input/output, 16 channels, plastic, Ethernet	AXL E ETH DI8 DO8 M12 6P	2701532
Standard I/O device, digital input/output, 16 channels, plastic, Ethernet	AXL E ETH DIO16 M12 6P	2701534
Standard I/O device, digital input, 16 channels, plastic, PROFIBUS	AXL E PB DI16 M12 6P	2701498
Standard I/O device, digital input/output, 12 channels, plastic, PROFIBUS	AXL E PB DI8 DO4 2A M12 6P	2701502
Standard I/O device, digital input/output, 16 channels, plastic, PROFIBUS	AXL E PB DI8 DO8 M12 6P	2701497
Standard I/O device, digital input/output, 16 channels, plastic, PROFIBUS	AXL E PB DIO16 M12 6P	2701499
Standard I/O device, digital input, 16 channels, metal, PROFINET	AXL E PN DI16 M12 6M	2701516
Standard I/O device, digital input, 16 channels, plastic, PROFINET	AXL E PN DI16 M12 6P	2701510
Standard I/O device, digital input/output, 12 channels, metal, PROFINET	AXL E PN DI8 DO4 2A M12 6M	2701518
Standard I/O device, digital input/output, 12 channels, plastic, PROFINET	AXL E PN DI8 DO4 2A M12 6P	2701512
Standard I/O device, digital input/output, 16 channels, metal, PROFINET	AXL E PN DI8 DO8 M12 6M	2701515
Standard I/O device, digital input/output, 16 channels, plastic, PROFINET	AXL E PN DI8 DO8 M12 6P	2701509
Standard I/O device, digital input/output, 16 channels, metal, PROFINET	AXL E PN DIO16 M12 6M	2701517
Standard I/O device, digital input/output, 16 channels, plastic, PROFINET	AXL E PN DIO16 M12 6P	2701511

Type	Designation	Order No.
Axioline E: Standard I/O devices		
Standard I/O device, digital input, 16 channels, plastic, Sercos	AXL E S3 DI16 M12 6P	2701544
Standard I/O device, digital input/output, 12 channels, plastic, Sercos	AXL E S3 DI8 DO4 2A M12 6P	2701546
Standard I/O device, digital input/output, 16 channels, plastic, Sercos	AXL E S3 DI8 DO8 M12 6P	2701542
Standard I/O device, digital input/output, 16 channels, plastic, Sercos	AXL E S3 DIO16 M12 6P	2701545
Axioline E: IO-Link master		
IO-Link master, 8 ports, 4 digital inputs, metal, EtherCAT®	AXL E EC IOL8 DI4 M12 6M	2701531
IO-Link master, 8 ports, 4 digital inputs, plastic, EtherCAT®	AXL E EC IOL8 DI4 M12 6P	2701524
IO-Link master, 8 ports, 4 digital inputs, metal, EtherNet/IP	AXL E EIP IOL8 DI4 M12 6M	2701491
IO-Link master, 8 ports, 4 digital inputs, plastic, EtherNet/IP	AXL E EIP IOL8 DI4 M12 6P	2701496
IO-Link master, 8 ports, 4 digital inputs, plastic, Ethernet	AXL E ETH IOL8 DI4 M12 6P	2701536
IO-Link master, 8 ports, 4 digital inputs, plastic, PROFIBUS	AXL E PB IOL8 DI4 M12 6P	2701503
IO-Link master, 8 ports, 4 digital inputs, metal, PROFINET	AXL E PN IOL8 DI4 M12 6M	2701519
IO-Link master, 8 ports, 4 digital inputs, plastic, PROFINET	AXL E PN IOL8 DI4 M12 6P	2701513
IO-Link master, 8 ports, 4 digital inputs, plastic, Sercos	AXL E S3 IOL8 DI4 M12 6P	2701547
Axioline E: IO-Link I/O boxes and analog converters		
IO-Link I/O box, digital input, 16 channels, plastic	AXL E IOL DI16 M12 6P	2702660
IO-Link I/O box, digital input, 8 channels, plastic	AXL E IOL DI8 M12 6P	2702658
IO-Link I/O box, digital output, 8 channels, plastic	AXL E IOL DO8 M12 6P	2702659
IO-Link analog converter, analog input, 1 channel, current, angled	AXL E IOL AI1 I M12 R	2700275
IO-Link analog converter, analog input, 1 channel, current, straight	AXL E IOL AI1 I M12 S	2700338
IO-Link analog converter, analog input, 1 channel, voltage, angled	AXL E IOL AI1 U M12 R	2700273
IO-Link analog converter, analog input, 1 channel, voltage, straight	AXL E IOL AI1 U M12 S	2700336
IO-Link analog converter, analog output, 1 channel, current, angled	AXL E IOL AO1 I M12 R	2700282
IO-Link analog converter, analog output, 1 channel, current, straight	AXL E IOL AO1 I M12 S	2700351
IO-Link analog converter, analog output, 1 channel, voltage, angled	AXL E IOL AO1 U M12 R	2700278
IO-Link analog converter, analog output, 1 channel, voltage, straight	AXL E IOL AO1 U M12 S	2700350
IO-Link analog converter, analog input, 1 channel, temperature, angled	AXL E IOL RTD1 M12 R	2700305
IO-Link analog converter, analog input, 1 channel, temperature, straight	AXL E IOL RTD1 M12 S	2700352
IO-Link analog converter, analog input, 4 channels, thermocouple	AXL E IOL TC4/K M12	2702983
Accessories		
Mounting plate	AXL E MP 60	2701761
Locking screw	PROT-M12	1680539
Snap-in markers	UCT-EM (7X10)	0830765

